

PROGRAMMABLE CONTROLLER  
FP0H Control Unit  
**User's Manual**

---

Basic

(MEMO)

## Introduction

Thank you for purchasing a Panasonic product. Before you use the product, please carefully read through the user's manual, and understand it in detail to use the product properly.

## Types of Manual

- There are different types of user's manual for the FP0H series. Please refer to a relevant manual for the unit and purpose of your use.
- The manuals can be downloaded on our download center: [https://industrial.panasonic.com/ac/e/dl\\_center/](https://industrial.panasonic.com/ac/e/dl_center/).

Unit name or purpose of use	Manual name	Manual code
FP0H Control Unit	FP0H User's Manual (Basic)	WUME-FP0HBAS
	FP0H Programming Manual	WUME-FP0HPGR
	FP0H Programming Manual (SD Card Access Instructions)	WUME-FP0HSD
Positioning Function/PWM Output/High-speed Counter Function	FP0H User's Manual (Positioning/PWM Output/High-speed Counter)	WUME-FP0HPOS
Serial Communication Function	FP0H User's Manual (COM Communication)	WUME-FP0HCOM
Ethernet Communication Function	FP0H User's Manual (Ethernet Communication)	WUME-FP0HET
EtherNet/IP Communication Function	FP0H User's Manual (EtherNet/IP)	WUME-FP0HEIP
Logging trace function	FP0H User's Manual (Logging/Trace Function)	WUME-FP0HLOG
FP0H Extension (Communication) Cassette	FP0H User's Manual (COM Communication)	WUME-FP0HCOM
FP0H Positioning Unit	FP0H Positioning Unit User's Manual	WUME-FP0HPG
FP0H Positioning Unit RTEX	FP0H Positioning Unit RTEX User's Manual (FPWIN GR7)	WUME-FP0HRTEXGR7

## Abbreviated Notation of Products

In this manual, product names are abbreviated to simplify descriptions.

Type	Output format	Product no.	Abbreviation 1	Abbreviation 2
Type without Ethernet function	NPN	AFP0HC32T	C32T	C32
	PNP	AFP0HC32P	C32P	
Type with Ethernet function	NPN	AFP0HC32ET	C32ET	C32E
	PNP	AFP0HC32EP	C32EP	

## SAFETY PRECAUTIONS

- To prevent accidents or personal injuries, please be sure to comply with the following items.
- Prior to installation, operation, maintenance and check, please read this manual carefully for proper use.
- Before using, please fully understand the knowledge related to the equipment, safety precautions and all other precautions.
- Safety precautions are divided into two levels in this manual: Warning and Caution.

 **WARNING** Incorrect operation may lead to death or serious injury.

- Take appropriate safety measures to the external circuit of the product to ensure the security of the whole system in case of abnormalities caused by product failure or external.
- Do not use this product in areas with inflammable gases.  
Otherwise it may lead to an explosion.
- Do not put this product into a fire.  
Otherwise it could cause damage to the battery or other electronic parts.

 **CAUTION** Incorrect operation may lead to injury or material loss.

- To prevent the excessive exothermic heat or smoke generation of the product, a certain margin is required for guaranteed characteristics and performance ratings of relative products.
- Do not decompose or transform it.  
Otherwise it will lead to the excessive exothermic heat or smoke generation of the product.
- Do not touch terminal blocks during power-on.  
Otherwise it may result in an electric shock.
- Set an emergency stop and interlock circuit in the external devices.
- Connect wires and connectors reliably.  
Otherwise it may lead to the excessive exothermic heat or smoke generation of the product.
- Do not undertake construction (such as connection and disconnection) while the power supply is on.  
It could lead to an electric shock.
- If the equipment is used in a manner not specified by the Panasonic, the protection provided by the equipment may be impaired.
- This product has been developed/produced for industrial use only.

## Description on Copyright and Trademarks

- The copyright of this manual is owned by **Panasonic Industrial Devices SUNX Co., Ltd**
- Unauthorized reproduction of this manual is strictly prohibited.
- Windows is a registered trademark of Microsoft Corporation in the U.S. and other countries.
- Ethernet is a registered trademark of FUJIFILM Business Innovation Corp. and Xerox Corporation.
- EtherNet/IP is a registered trademark of ODVA (Open DeviceNet Vendor Association).
- SDHC and SD logos are trademarks of LLC.
- This product uses software including open source software. Regarding the published source code and license of the open source software, refer to the next section.
- Other company and product names are trademarks or registered trademarks of their respective companies.

## Open Source Software License

These are distributed with an expectation that they are useful by themselves, but Panasonic makes no warranty, including implied warranty of MERCHANTABILITY or FITNESS FOR SPECIAL PURPOSE. For details, refer to the following License Terms of Conditions.

Camellia assembler implementation.

Copyright (c) 2008 Andy Polyakov <appro@openssl.org>

Redistribution and use in source and binary forms, with or without modification, are permitted provided that the following conditions are met:

1. Redistributions of source code must retain the above copyright notice, this list of conditions and the following disclaimer as the first lines of this file unmodified.
2. Redistributions in binary form must reproduce the above copyright notice, this list of conditions and the following disclaimer in the documentation and/or other materials provided with the distribution.

THIS SOFTWARE IS PROVIDED BY Andy Polyakov ``AS IS'' AND ANY EXPRESS OR IMPLIED WARRANTIES, INCLUDING, BUT NOT LIMITED TO, THE IMPLIED WARRANTIES OF MERCHANTABILITY AND FITNESS FOR A PARTICULAR PURPOSE ARE DISCLAIMED. IN NO EVENT SHALL NTT BE LIABLE FOR ANY DIRECT, INDIRECT, INCIDENTAL, SPECIAL, EXEMPLARY, OR CONSEQUENTIAL DAMAGES (INCLUDING, BUT NOT LIMITED TO, PROCUREMENT OF SUBSTITUTE GOODS OR SERVICES; LOSS OF USE, DATA, OR PROFITS; OR BUSINESS INTERRUPTION) HOWEVER CAUSED AND ON ANY THEORY OF LIABILITY, WHETHER IN CONTRACT, STRICT LIABILITY, OR TORT (INCLUDING NEGLIGENCE OR OTHERWISE) ARISING IN ANY WAY OUT OF THE USE OF THIS SOFTWARE, EVEN IF ADVISED OF THE POSSIBILITY OF SUCH DAMAGE.

(MEMO)

# Table of Contents

<b>1 System Configuration</b>	<b>1-1</b>
1.1 Overview of System	1-2
1.1.1 Type of Control Unit	1-2
1.2 List of Unit Model Numbers	1-4
1.2.1 FP0H Control Units	1-4
1.2.2 FP0H Extension (Communication) Cassettes	1-4
1.2.3 FP0H Expansion Unit / Intelligent Unit (Installed on the Left Side)	1-4
1.2.4 FPsigma Expansion Units (Installed on the Left Side)	1-5
1.2.5 FP0R Expansion Units (Installed on the Right Side)	1-5
1.2.6 FP0/FP0R Intelligent Units (Installed on the Right Side)	1-6
1.2.7 Options	1-6
1.2.8 Maintenance Parts	1-7
1.3 Restrictions on Combinations of Units	1-8
1.3.1 Restrictions on Using Expansion Units	1-8
1.3.2 Restrictions on Communication Functions	1-9
1.3.3 Restrictions on Combined Use of Functions	1-9
1.4 Programming Tools	1-10
1.4.1 Software Usage Environment and Applicable Cables	1-10
1.4.2 Selection of SD Memory Cards	1-10
<b>2 FP0H Control Unit Specifications</b>	<b>2-1</b>
2.1 Names and Functions of Parts	2-2
2.1.1 AFP0HC32ET/AFP0HC32EP	2-2
2.1.2 AFP0HC32T/AFP0HC32P	2-3
2.1.3 Specifications of Operation Indicator LEDs	2-5
2.2 Power Supply Specifications	2-7
2.2.1 DC Power Supply	2-7
2.3 Input and Output Specifications	2-8
2.3.1 Input Specifications	2-8
2.3.2 Output Specifications	2-9
2.4 Terminal Layout	2-11
<b>3 Specifications of FP0H Expansion Unit</b>	<b>3-1</b>
3.1 Names and Functions of Parts	3-2
3.2 Input and Output Specifications	3-3
3.2.1 Input specifications	3-3
3.2.2 Output Specifications	3-4
3.3 Terminal Layout	3-6
<b>4 Allocation of I/O Numbers</b>	<b>4-1</b>
4.1 Basics of I/O Allocation	4-2
4.1.1 How to Count I/O Numbers	4-2
4.1.2 Concept of I/O Number Allocation	4-2
4.2 List of I/O Numbers for Each Unit	4-5

4.2.1	FP0H Control Unit .....	4-5
4.2.2	FP0H/FPsigma Expansion Units .....	4-5
4.2.3	FP0/FP0R Expansion Units .....	4-5
4.2.4	Types and I/O Numbers of FP0R Expansion Units .....	4-5
4.2.5	Types and I/O Numbers of FP0 Intelligent Units .....	4-7
<b>5</b>	<b>Installation and Wiring.....</b>	<b>5-1</b>
5.1	Installation .....	5-2
5.1.1	Installation Environment and Space .....	5-2
5.2	Installation of Backup Battery .....	5-4
5.2.1	Installation of Backup Battery .....	5-4
5.3	Installation of Extension (Communication) Cassette .....	5-5
5.3.1	Precautions When Installing Extension (Communication) Cassette .....	5-5
5.3.2	Installing Extension (Communication) Cassette .....	5-5
5.4	Connection of Expansion Unit.....	5-6
5.4.1	Connection of FP0/FP0R Expansion Unit.....	5-6
5.4.2	Connection of FP0H/FPsigma Expansion Unit .....	5-6
5.5	Installation.....	5-8
5.5.1	Attachment to DIN rail .....	5-8
5.5.2	Removal from DIN rail.....	5-8
5.6	Wiring of Power Supply.....	5-9
5.6.1	Common Precautions .....	5-9
5.6.2	Power Supply of FP0H Control Unit / FP0/FP0R Expansion Unit....	5-10
5.6.3	Grounding .....	5-11
5.7	Wiring of Input and Output.....	5-13
5.7.1	Precautions on Wirings of Input and Output .....	5-13
5.7.2	Input Wiring .....	5-13
5.7.3	Output Wiring .....	5-14
5.8	Connection Using the Discrete-wire Connector .....	5-16
5.8.1	Specifications of the Discrete-wire Connector .....	5-16
5.8.2	Wiring the Discrete-wire Connector .....	5-17
5.9	Safety Measures .....	5-20
5.9.1	Safety Measures .....	5-20
5.9.2	Instantaneous Power Failure .....	5-20
5.9.3	Watchdog Timer .....	5-20
<b>6</b>	<b>Procedures Before Starting Operation .....</b>	<b>6-1</b>
6.1	Before Turning On the Power .....	6-2
6.1.1	Check Items .....	6-2
6.1.2	Procedures Before Starting Operation .....	6-2
6.2	Offline Editing of Project .....	6-4
6.2.1	Elements of Project .....	6-4
6.2.2	System Register Settings.....	6-4
6.2.3	Setting of Positioning Parameters.....	6-6
6.3	Project Download and Operation .....	6-7
6.3.1	Before Turning On the Power .....	6-7
6.3.2	Project Download and Mode Switching .....	6-8
6.3.3	Procedure for downloading .....	6-8



6.3.4	If "MEWNET device open error" occurs .....	6-9
6.3.5	Totally Checking Project.....	6-10
6.3.6	Verifying Project .....	6-11
6.4	Online Edit .....	6-14
6.4.1	Overview of Online Edit .....	6-14
6.4.2	Online Edit of Program.....	6-14
6.4.3	Procedure of rewriting blocks.....	6-15
6.4.4	Online Edit of System Register .....	6-16
6.5	Program Block .....	6-17
6.5.1	Overview of Program Block .....	6-17
6.5.2	Changing the Execution Order of Program Blocks .....	6-17
<b>7</b>	<b>Memory Backup .....</b>	<b>7-1</b>
7.1	Memory Backup .....	7-2
7.1.1	Backup of Program Memory .....	7-2
7.1.2	Backup of Operation Memory .....	7-2
7.1.3	Backup of Operation Memory (With Battery) .....	7-4
7.1.4	Settings of Battery Error Alarm and Hold Area .....	7-5
7.2	RAM / ROM Transfer Function .....	7-7
7.2.1	Overview of Functions .....	7-7
7.2.2	Operation Using Tool Software .....	7-7
7.3	Transfer Using SD Memory Card (C32ET/C32EP).....	7-8
7.3.1	Transfer using SD Memory Card: Overview of Functions.....	7-8
7.3.2	Operation Using Tool Software .....	7-8
<b>8</b>	<b>Security Function.....</b>	<b>8-1</b>
8.1	Password Protect Function .....	8-2
8.1.1	Overview of Functions .....	8-2
8.1.2	Setting using FPWIN GR7 .....	8-2
8.1.3	Set PLC Password dialog box .....	8-3
8.1.4	Setting to prohibit access with a password .....	8-4
8.1.5	Setting to allow access with a password.....	8-5
8.1.6	Canceling the password protection .....	8-6
8.1.7	Unprotect .....	8-6
8.1.8	Force cancel .....	8-7
8.2	Program Upload Protection Function.....	8-9
8.2.1	Overview of Functions .....	8-9
8.2.2	Configuration.....	8-9
8.2.3	Force cancel .....	8-10
8.3	Availability of Security Function .....	8-11
8.3.1	Control Unit .....	8-11
<b>9</b>	<b>Other Functions .....</b>	<b>9-1</b>
9.1	Clock/calender .....	9-2
9.1.1	Overview of Function .....	9-2
9.1.2	Clock/calendar Setting .....	9-2
9.1.3	Application Example of Clock/calendar.....	9-3
9.2	Potentiometer Input (C32T/C32P) .....	9-5
9.2.1	Overview of Functions .....	9-5

9.2.2	Example Showing How to Use Potentiometer Input .....	9-5
9.3	Input Time Constant Setting Function.....	9-6
9.3.1	Overview of Functions .....	9-6
9.4	FPsiigma Mode.....	9-7
9.4.1	Overview of FPsiigma Mode .....	9-7
9.4.2	Converting Projects for FPsiigma to Projects for FP0H (FPsiigma Mode).....	9-8
9.4.3	Converting Projects for FP0H (FPsiigma Mode) to Projects for FP0H (FP0H Mode) .....	9-9
<b>10</b>	<b>Troubleshooting.....</b>	<b>10-1</b>
10.1	Self-diagnostic Function.....	10-2
10.1.1	Operation monitor LEDs of Control Unit .....	10-2
10.1.2	Operation Mode When an Error Occurs .....	10-2
10.2	What to Do If an Error Occurs.....	10-4
10.2.1	ERR/ALM LED Flashes .....	10-4
10.2.2	Mode does Not Change to RUN Mode .....	10-5
10.2.3	ERR/ALM LED Lights .....	10-5
10.2.4	ALL LEDs are OFF .....	10-6
10.2.5	A Protect Error Message Appears .....	10-6
10.2.6	Diagnosing Output Malfunction.....	10-7
10.2.7	Communication Error Occurs (RS-232C) .....	10-8
10.2.8	Communication Error Occurs (RS-485).....	10-9
<b>11</b>	<b>Maintenance and Inspection .....</b>	<b>11-1</b>
11.1	Handling of Backup Battery.....	11-2
11.1.1	Replacement of Backup Battery.....	11-2
11.1.2	Lifetime and Time for Replacement of Backup Battery .....	11-3
11.2	Inspection.....	11-4
<b>12</b>	<b>Specifications.....</b>	<b>12-1</b>
12.1	Control Unit Specifications.....	12-2
12.1.1	General Specifications .....	12-2
12.1.2	Performance Specifications .....	12-4
12.2	Communication Function Specifications .....	12-8
12.2.1	Communication Specifications of Control Unit.....	12-8
12.2.2	Communication Cassette Specifications.....	12-9
12.3	Operation Memory Area.....	12-11
12.4	List of System Registers .....	12-13
12.5	List of Special Relays.....	12-22
12.6	List of Special Data Registers.....	12-43
12.7	List of Basic Instructions .....	12-63
12.8	List of High-level Instructions .....	12-69
12.9	List of Error Codes .....	12-81
12.9.1	List of Syntax Check Errors .....	12-81
12.9.2	Self-diagnostic Errors.....	12-82
12.9.3	List of MEWTOCOL-COM Communication Error Codes .....	12-84

12.10 Dimensions .....	12-86
12.10.1 AFP0HC32T/AFP0HC32P .....	12-86
12.10.2 AFP0HC32ET/AFP0HC32EP .....	12-86

(MEMO)

# 1 System Configuration

---

1.1 Overview of System .....	1-2
1.1.1 Type of Control Unit .....	1-2
1.2 List of Unit Model Numbers.....	1-4
1.2.1 FP0H Control Units .....	1-4
1.2.2 FP0H Extension (Communication) Cassettes.....	1-4
1.2.3 FP0H Expansion Unit / Intelligent Unit (Installed on the Left Side) ..	1-4
1.2.4 FPsigma Expansion Units (Installed on the Left Side).....	1-5
1.2.5 FP0R Expansion Units (Installed on the Right Side) .....	1-5
1.2.6 FP0/FP0R Intelligent Units (Installed on the Right Side) .....	1-6
1.2.7 Options.....	1-6
1.2.8 Maintenance Parts .....	1-7
1.3 Restrictions on Combinations of Units .....	1-8
1.3.1 Restrictions on Using Expansion Units .....	1-8
1.3.2 Restrictions on Communication Functions.....	1-9
1.3.3 Restrictions on Combined Use of Functions.....	1-9
1.4 Programming Tools .....	1-10
1.4.1 Software Usage Environment and Applicable Cables .....	1-10
1.4.2 Selection of SD Memory Cards.....	1-10

## 1.1 Overview of System

### 1.1 Overview of System

#### 1.1.1 Type of Control Unit

The main differences depending on type of control unit are described below.

##### ■ Main comparison of specifications

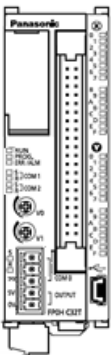
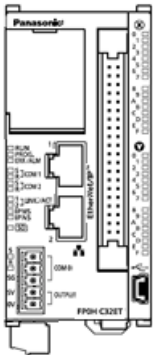
Item	Type without Ethernet function		Type with Ethernet function	
	AFP0HC32T/ AFP0HC32P		AFP0HC32ET/ AFP0HC32EP	
Appearance				
Program capacity <sup>(Note 1)</sup>	24K / 32K steps		24K / 32K / 40K / 64K steps	
Data register capacity <sup>(Note 1)</sup>	65533 / 32765 words		65533 / 32765 / 24573 / 12285 words	
Communication I/F	For tool	USB port	USB port	
	For external devices <sup>(Note 2)</sup>	RS-232C port	RS-232C port	LAN port x 2 <sup>(Note 3)</sup>
Supported communication protocol	PLC link (MEWNET-W0) MEWTOCOL-COM MODBUS-RTU General-purpose communication		PLC link (MEWNET-W0) MEWTOCOL-COM MODBUS-RTU General-purpose communication	EtherNet/IP MEWTOCOL-COM MEWTOCOL-DAT MODBUS-TCP MC protocol General-purpose communication
SD memory card slot	None		Available	
Logging trace	Not available		Available	
Sampling trace	Available		Available	
Potentiometer input	Available x 2		None	
Dimensions	W 30.4×H 90×D60		W 42.4×H 90×D60	

(Note 1) Program capacities and data register capacities vary according to the setting of the system register no. 0. In the FPsigma mode, only 24K/32K steps and 65533/32765 words can be selected for program capacity and data register capacity respectively.

- (Note 2) Extension communication cassettes dedicated to the FP0H (RS-232C/RS-485) (Sold separately) can also be attached. The above external view show the state when the extension communication cassette is attached.
- (Note 3) The IP address and MAC address are common to the both LAN ports.

## 1.2 List of Unit Model Numbers

### 1.2 List of Unit Model Numbers

#### 1.2.1 FP0H Control Units

Item name	Specifications	Product no.
FP0H C32T Control Unit	16-point DC input, 16-point transistor output (NPN), 24 VDC power supply, Ethernet function is unavailable.	AFP0HC32T
FP0H C32P Control Unit	16-point DC input, 16-point transistor output (PNP), 24 VDC power supply, Ethernet function is unavailable.	AFP0HC32P
FP0H C32ET Control Unit	16-point DC input, 16-point transistor output (NPN), 24 VDC power supply, Ethernet function is available.	AFP0HC32ET
FP0H C32EP Control Unit	16-point DC input, 16-point transistor output (PNP), 24 VDC power supply, Ethernet function is available.	AFP0HC32EP

#### 1.2.2 FP0H Extension (Communication) Cassettes

Item name	Specifications	Product no.
FP0H communication cassette	RS-232C (5-wire type) x 1 channel (Non-isolated)	AFP0HCCS1
	RS-232C (3-wire type) x 2 channels (Non-isolated)	AFP0HCCS2
	RS-485 x 1 channel (Isolated)	AFP0HCCM1
	RS-485 x 1 channel (Isolated) / RS-232C x 1 channel (Non-isolated)	AFP0HCCS1M1

#### 1.2.3 FP0H Expansion Unit / Intelligent Unit (Installed on the Left Side)

Item name	Specifications	Product no.
FP0H Expansion I/O Unit	32-point DC input, 32-point transistor output (NPN)	AFP0HXY62D2T
	32-point DC input, 32-point transistor output (PNP)	AFP0HXY64D2P
FP0H Positioning Unit	1-axis transistor speed command: 1 pps to 500 kpps	AFP0HPG01T
	1-axis line driver speed command: 1 pps to 4 Mpps	AFP0HPG01L
	2-axis transistor speed command: 1 pps to 500 kpps	AFP0HPG02T
	2-axis line driver speed command: 1 pps to 4 Mpps	AFP0HPG02L
FP0H Positioning Unit RTEX	4-axis type speed command: 1pps to 2Gpps	AFP0HM4N
	8-axis type speed command: 1pps to 2Gpps	AFP0HM8N



### 1.2.4 FPsigma Expansion Units (Installed on the Left Side)

Item name	Specifications	Product no.
FPsigma Positioning Unit RTEX	2-axis type speed command: 1 pps to 32 Mpps	AFPG43610
	4-axis type speed command: 1 pps to 32 Mpps	AFPG43620
	8-axis type speed command: 1 pps to 32 Mpps	AFPG43630
FPsigma CC-Link Slave Unit	Unit connected to CC-Link	AFPG7943

### 1.2.5 FP0R Expansion Units (Installed on the Right Side)

Item name	Specifications					Product no.
	No. of inputs/outputs	Power supply voltage	Input specifications	Output specifications	Connection type	
FP0R-E8 Expansion Unit	8 points (Input: 8 points)	-	24 VDC ±common	-	MIL connector	AFP0RE8X
	8 points (Input: 4 points/ Output: 4 points)	24V DC	24 VDC ±common	Relay output: 2A	Terminal block	AFP0RE8RS
					Molex connector	AFP0RE8RM
	8 points (Output: 8 points)	24V DC	-	Relay output: 2A	Terminal block	AFP0RE8YRS
	8 points (Output: 8 points)	-	-	Transistor output: (NPN) 0.3A	MIL connector	AFP0RE8YT
8 points (Output: 8 points)	-	-	Transistor output: (PNP) 0.3A	MIL connector	AFP0RE8YP	
FP0R-E16 Expansion Unit	16 points (Input: 16 points)	-	24 VDC ±common	-	MIL connector	AFP0RE16X
	16 points (Input: 8 points/ Output: 8 points)	24V DC	24 VDC ±common	Relay output: 2A	Terminal block	AFP0RE16RS
					Molex connector	AFP0RE16RM
	16 points (Input: 8 points/ Output: 8 points)	-	24 VDC ±common	Transistor output: (NPN) 0.3A	MIL connector	AFP0RE16T
16 points	-	24 VDC ±common	Transistor output: (PNP) 0.3A	MIL connector	AFP0RE16P	

## 1.2 List of Unit Model Numbers

Item name	Specifications					Product no.
	No. of inputs/ outputs	Power supply voltage	Input specifications	Output specifications	Connection type	
	(Input: 8 points/ Output: 8 points)					
	16 points (Output: 16 points)	-	-	Transistor output: (NPN) 0.3A	MIL connector	AFP0RE16YT
	16 points (Output: 16 points)	-	-	Transistor output: (PNP) 0.3A	MIL connector	AFP0RE16YP
FP0R-E32 Expansion Unit	32 points (Input: 16 points/ Output: 16 points)	-	24 VDC ±common	Transistor output: (NPN) 0.3A	MIL connector	AFP0RE32T
	32 points (Input: 16 points/ Output: 16 points)	-	24 VDC ±common	Transistor output: (PNP) 0.3A	MIL connector	AFP0RE32P

### 1.2.6 FP0/FP0R Intelligent Units (Installed on the Right Side)

Item name	Specifications	Product no.
FP0R Analog Input Unit	4-ch input	AFP0RAD4
	8-ch input	AFP0RAD8
FP0R Analog I/O Unit	2-ch Input, 1-ch output	AFP0RA21
	4-ch Input, 2-ch output	AFP0RA42
FP0R Analog Output Unit	4-ch output	AFP0RDA4
FP0 Thermocouple Unit	4-channel input, K, J, T, R thermocouples, resolution: 0.1°C	AFP0420
	8-channel input, K, J, T, R thermocouples, resolution: 0.1°C	AFP0421

### 1.2.7 Options

Item name	Specifications	Product no.
Backup battery	Battery to back up the clock/calendar operation. Common to FP-X and FP7	AFPX-BATT

## 1.2 List of Unit Model Numbers

Item name		Specifications	Product no.
Wiring tools	Terminal screwdriver	Driver for connecting the terminal block (made by Phoenix Contact Co.) supplied with COM terminals or cassettes	AFP0806
	Multi-wire connector pressure contact tool	Tool for pressure welding the attached wire-press sockets	AXY52000FP
	Flat cable connector	Required for wiring with flat cables. 40P	AFP2802 (2-pack)

### 1.2.8 Maintenance Parts

Item name	Specifications		Product no.
Wire-press socket	Attached to FP0H/FPsigma I/O Units and FP0H/FPsigma Positioning Units. 40P		AFP2801 (2-pack)
Wire-press contact	For FP0H Control Units, FP0H/FPsigma Expansion I/O Units and FP0H/FPsigma Positioning Units.	Suitable wire: AWG #22 / AWG #24	AXW7221FP (5 pins in line)
		Suitable wire: AWG #26 / AWG #28	AXW7231FP (5 pins in line)
Power cable for FP0R/FPsigma	Attached to FP0H/FP0R/FPsigma Control Units. Length: 1 m		AFPG805 (1-pack)

(Note 1) Order wire-press contacts in units of 200 pins in 40 rows.

## 1.3 Restrictions on Combinations of Units

### 1.3 Restrictions on Combinations of Units

#### 1.3.1 Restrictions on Using Expansion Units

##### ■ Restrictions on the Number of Expansion Units and Mounting Order

- Up to four units of FP0H/FPsigma Expansion Units/Intelligent Units can be installed on the left side of the FP0H Control Unit. However, note that only up to two units of FP0H/FPsigma Positioning Unit RTEX can be installed.
- Up to three of FP0/FP0R Expansion Units/Intelligent units can be installed on the right side of the FP0H Control Unit.

(Note): If the number of installed units exceeds the prescribed value, the self-diagnostic error (24: Unit installed limit) will occur.

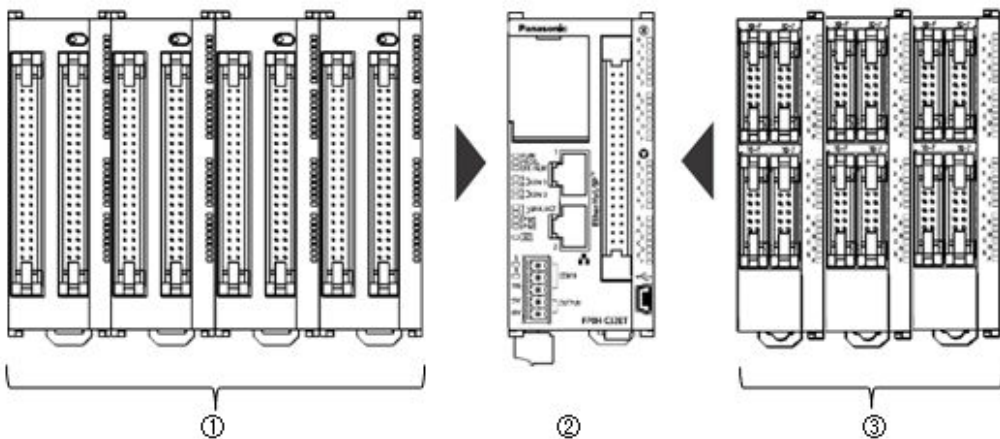

(1)	FP0H/FPsigma Expansion Units	(2)	FP0H Control Unit	(3)	FP0/FP0R Expansion Units
-----	------------------------------	-----	-------------------	-----	--------------------------

##### ■ Maximum number of control inputs/outputs

Type of unit	Control unit No. of inputs/outputs of a single control unit	No. of inputs/outputs when using expansion units
FP0H Control Unit	32 points	Max. 384 points

(Note 1) This is the number of points when combining with the transistor type FP0R expansion unit.

##### ■ Restrictions on combinations of Expansion Units

- Install the FP0 Thermocouple Unit on the right side of all other expansion units. If it is installed on the left side, the total precision will deteriorate.
- Install the FP0 CC-Link Slave Unit on the right side of the other expansion units. There is no expansion connector on the right side.

### 1.3.2 Restrictions on Communication Functions

- There are the following restrictions on functions to be used when using the communication ports equipped with the control unit and communication cassettes.
- Allocated communication port numbers vary according to the mounting positions of cassettes.

■ **Types of communication ports/communication cassettes (●: Available, ○: Conditionally available, Blank: Not available)**

Product no.	Communication interface	Control unit		Cassette	
		USB	COM0	COM1	COM2
Control Unit standard equipment	USB x 1 channel	●			
	RS-232C (3-wire) x 1 channel		●		
AFP0HCCS1	RS-232C (5-wire) x 1 channel			●	
AFP0HCCS2	RS-232C (3-wire) x 2 channel			●	●
AFP0HCCM1	RS-485 x 1 channel			●	
AFP0HCCS1M1	RS-485 x 1 channel			●	
	RS-232C (3-wire) x 1 channel				●

(Note 1) The RS-232C port of AFP0HCCS1 is a 5-wire type, and the RS/CS control can be performed.

(Note 2) The both 1-channel RS-485 and 1-channel RS-232C (3-wire type) can be used for AFP0HCCS1M1.

■ **Available functions for each communication port (●: Available, ○: Conditionally available, Blank: Not available)**

Communication function to be used		Control unit		Cassette	
		USB	COM0	COM1	COM2
PLC Link			○(Note 1)	○(Note 1)	
MEWTOCOL-COM	Master		●	●	●
	Slave	●	●	●	●
MODBUS-RTU	Master		●	●	●
	Slave		●	●	●
General-purpose communication			●	●	●

(Note 1) For the PLC link, either one of the standard COM0 port mounted in the control unit and the COM 1 port of a cassette can be used.

### 1.3.3 Restrictions on Combined Use of Functions

- For FP0H series, communication with external devices can be performed via up to a maximum of three communication interfaces in combination of the standard COM0 port mounted in the control unit and the COM1 to COM2 ports of communication cassette.
- When using all three ports (COM0 to COM2), the usable baud rate is up to 115.2 kbps and usable pulse output function is up to 4 axes.

## 1.4 Programming Tools

### 1.4 Programming Tools

#### 1.4.1 Software Usage Environment and Applicable Cables

##### ■ Programming software

Item name	Applicable version	Supported language	Product no.	Remarks
Control FPWIN GR7	Ver.2.19 or later	English	AFPSGR7EN	-
			AFPSGR7ENS	Version compatible with FP7 encryption function
Control FPWIN Pro7	Ver.7.2.0 or later	Japanese/English Chinese/Korean	AFPSPR7A	-
			AFPSPR7AS	Version compatible with FP7 encryption function

(Note 1) When combining with the FP0H Positioning Units RTEX, use the FP0H Control Unit and Programming software with the following versions.

- FP0H Control Unit: Ver.1.3.0 or later
- Control FPWIN GR7 : Ver.2.26.0 or later
- Control FPWIN Pro7 : Ver.7.3.0 or later

(Note 2) The difference file to update the software to the latest version can be downloaded at our download center free of charge. Use the latest version.

Our download center : [https://industrial.panasonic.com/ac/j/dl\\_center/](https://industrial.panasonic.com/ac/j/dl_center/)

##### ■ Operating environment

Item	Specifications
OS	Windows® 10 (32-bit version/64-bit version) Windows® 8.1 (32-bit version/64-bit version) Windows® 8 (32-bit version/64-bit version) Windows® 7 SP1 or later (32-bit version/64-bit version)
Required hard disk space	FPWIN GR7 : 120 MB or more FPWIN Pro7 : 400 MB or more

##### ■ PC connectioncable

- Use a commercial USB cable.

Cable type	Length
USB2.0 cable (A: miniB)	Max. 5 m

#### 1.4.2 Selection of SD Memory Cards

For the Control Units with the Ethernet function (AFP0HC32ET/AFP0HC32EP), SD memory cards can be used for copying projects and logging/trace applications. Note the following points when selecting and using SD memory cards

### ■ Usable SD memory cards

We recommend SLC SD memory cards and SLC SDHC memory cards.

For details on operation confirmed SD memory card and SDHC memory card, visit

<https://industrial.panasonic.com/ac/e/fasys/information/sd-card/index.jsp..>

Control Unit printed logo	Usable SD memory cards	
	Card type	Capacity
	SD memory card	2GB
	SDHC memory card	4GB to 32GB

### ■ Cautions on handling an SD memory card

The data saved in the SD memory card may be lost in the following cases. We assume no responsibility whatsoever for the loss of saved data.

- The user or a third party has misused the SD memory card.
- When the SD memory card was affected by any static electricity or electrical noise.
- The SD memory card was taken out, or the PLC body was powered off, while the card was being accessed.

### ■ Formatting an SD memory card

In principle, SD memory cards have been formatted by the time of purchase, and no formatting by the user is required. If formatting becomes necessary, download formatting software for SD memory cards from the SD Association site.



- A file system formatted by PC's standard formatting software does not satisfy the SD memory card specifications. Please use the dedicated formatting software.
- It is recommended to save important data in another media for backup.
- Never remove the card or power off the PLC while accessing the card. Data may be damaged.
- Do not use an SD memory card the memory capacity of which is more than the usable capacity. Data in the card may be damaged.

(MEMO)



# 2 FP0H Control Unit Specifications

---

2.1	Names and Functions of Parts.....	2-2
2.1.1	AFP0HC32ET/AFP0HC32EP .....	2-2
2.1.2	AFP0HC32T/AFP0HC32P .....	2-3
2.1.3	Specifications of Operation Indicator LEDs .....	2-5
2.2	Power Supply Specifications.....	2-7
2.2.1	DC Power Supply.....	2-7
2.3	Input and Output Specifications .....	2-8
2.3.1	Input Specifications .....	2-8
2.3.2	Output Specifications .....	2-9
2.4	Terminal Layout.....	2-11

## 2.1 Names and Functions of Parts

### 2.1 Names and Functions of Parts

#### 2.1.1 AFP0HC32ET/AFP0HC32EP

##### ■ Type with Ethernet function

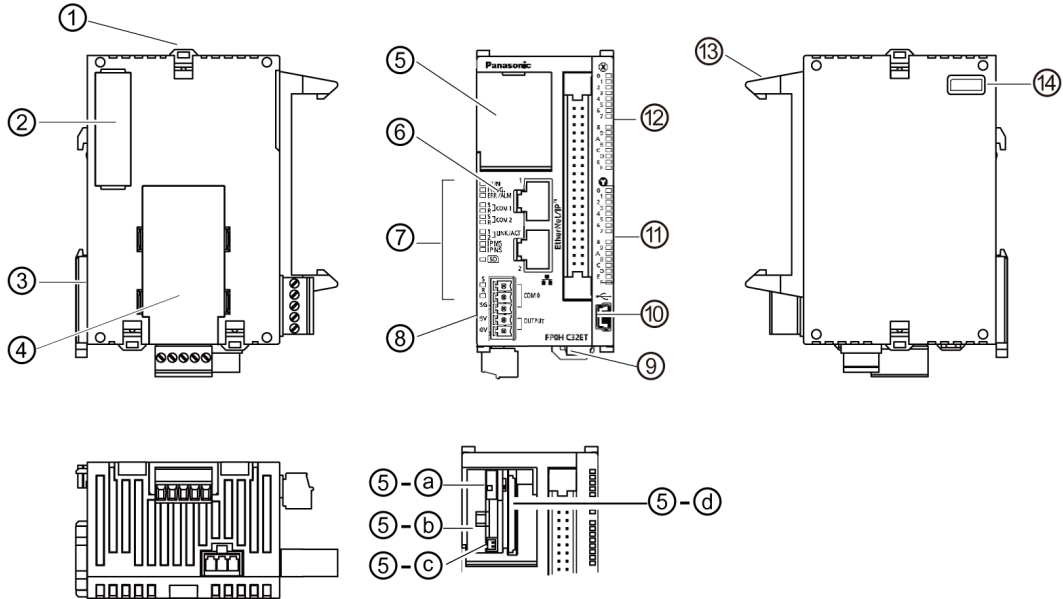

##### ■ Names and Functions of Parts

Number	Name	Function
(1)	Expansion hook	This hook is used to secure expansion units.
(2)	Left-side connector for expansion	This is used to connect the unit installed on the left side of the control unit to the internal circuit.
(3)	DIN hook	This is used to fix the unit on a DIN rail.
(4)	Extension (communication) cassette (Option)	This is a space for installing an optional communication cassette.
(5)	Battery cover	There are a built-in battery connector, RUN/PROG. mode selection switch and SD card slot. (Note 2)
-(a)	RUN/PROG. mode selection switch	RUN (Up): Sets to RUN mode. PROG. (Down): Sets to Program mode.
-(b)	Battery holder	This is used to install a dedicated battery (AFPX-BATT).
-(c)	Battery connector	This is used to insert the connector of a dedicated battery.
-(d)	SD memory card slot	Insert an SD memory card.
(6)	LAN port	Port for connecting to Ethernet LAN.

Number	Name	Function
(7)	Operation monitor LEDs	Indicates the operation status of PLC such as RUN/STOP and ERROR/ALARM and the communication status of COM0-2/LAN.
(8)	COM0 port terminal block (5P)	Three-wire RS-232C port. A power supply terminal (5 V) is also provided for connecting our Programmable Display GT02/GT02L series.
(9)	Power supply connector	Supply 24 VDC. It is connected using the power supply cable (AFPG805) supplied with the unit.
(10)	USB port	This is used to connect with a PC on which tool software is used.
(11)	Output indicator LEDs	Indicates the output state.
(12)	Input indicator LEDs	Indicates the input state.
(13)	I/O connector	This is used to connect an input device/output device.
(14)	Right-side connector for expansion	This is used to connect the unit installed on the right side of the control unit to the internal circuit. (The connector is located under the seal.)

(Note 1) Whether the switch is set to "RUN" or "PROG.", the mode can be switched through remote operation from the programming tool. When power is turned on again, it operates in the mode set on the switch.

(Note 2) Do not apply an excessive force to the card cover when opening or closing it or when the cover is left open. Otherwise, the cover attachment part will be deformed to cause malfunction in the cover recognition switch mounted inside the product.

### 2.1.2 AFP0HC32T/AFP0HC32P

#### ■ Type without Ethernet function

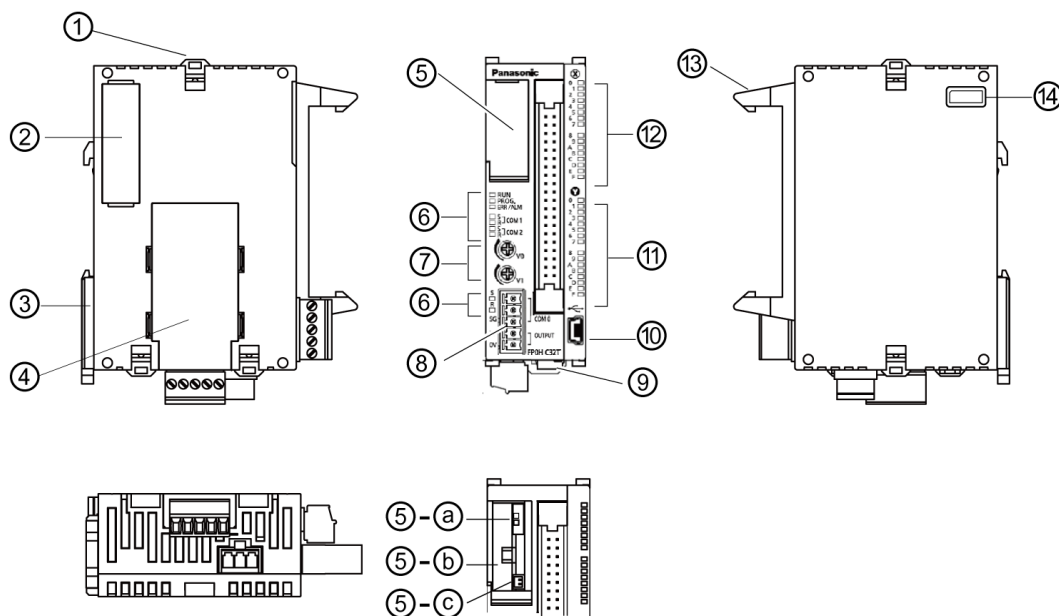

## 2.1 Names and Functions of Parts

### ■ Names and Functions of Parts

Number	Name	Function
(1)	Expansion hook	This hook is used to secure expansion units.
(2)	Left-side connector for expansion	This is used to connect the unit installed on the left side of the control unit to the internal circuit.
(3)	DIN hook	This is used to fix the unit on a DIN rail.
(4)	Extension (communication) cassette (Option)	This is a space for installing an optional communication cassette and function cassette.
(5)	Battery cover	There are a built-in battery connector and RUN/PROG. mode selection switch.
-(a)	RUN/PROG. mode selection switch	RUN (Up): Sets to RUN mode. PROG. (Down): Sets to Program mode.
-(b)	Battery holder	This is used to install a dedicated battery (AFPX-BATT).
-(c)	Battery connector	This is used to insert the connector of a dedicated battery.
(6)	Operation monitor LEDs	Indicates the operation status of PLC such as RUN/STOP and ERROR/ALARM and the communication status of COM0-2/LAN.
(7)	Potentiometer input	Turning the volumes changes the values of special DT. They can be used for the functions such as analog timer.
(8)	COM0 port terminal block (5P)	Three-wire RS-232C port. A power supply terminal (5 V) is also provided for connecting our Programmable Display GT02/GT02L series.
(9)	Power supply connector	Supply 24 VDC. It is connected using the power supply cable (AFPG805) supplied with the unit.
(10)	USB port	This is used to connect with a PC on which tool software is used.
(11)	Output indicator LEDs	Indicates the output state.
(12)	Input indicator LEDs	Indicates the input state.
(13)	I/O connector	This is used to connect an input device/output device.
(14)	Right-side connector for expansion	This is used to connect the unit installed on the right side of the control unit to the internal circuit. (The connector is located under the seal.)

(Note 1) Whether the switch is set to "RUN" or "PROG.", the mode can be switched through remote operation from the programming tool. When power is turned on again, it operates in the mode set on the switch.

2.1.3 Specifications of Operation Indicator LEDs

■ LED layout

Overall view

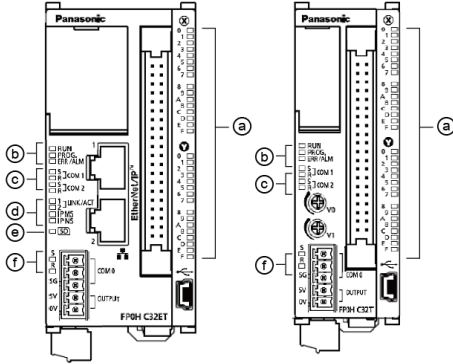

Enlarged view

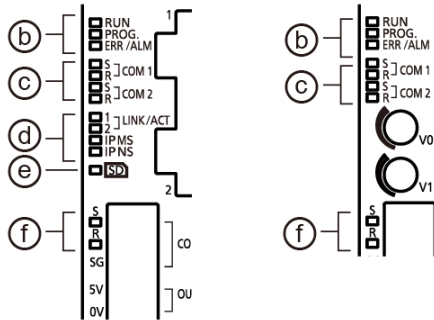

■ Specifications of LEDs

No.	LED name	Color	Data to Display	
(a)	X	Green	Indicates the input state.	
	Y	Green	Indicates the output state.	
(b)	RUN	Green	ON	Turns on when a program is being executed in RUN mode.
			Flashes	"RUN and PROG." LEDs flash alternately when the forced I/O function is executed in RUN mode.
	PROG.	Green	ON	Turns on when the unit operation stops in PROG. mode. Turns on when the forced I/O function is being executed in PROG. mode.
			Flashes	"RUN and PROG." LEDs flash alternately when the forced I/O function is executed in RUN mode.
	ERR/ALM	Red	ON	This lights if a hardware error occurs, or operation slows because of the program, and the watchdog timer is activated.
			Flashes	Lit when an error is detected by self-diagnosis.

## 2.1 Names and Functions of Parts

No.	LED name	Color	Data to Display
(c)	COM1/ COM2	S	Green Flashes when data is sent via the COM1/COM2 port.
		R	Green Flashes when data is received via the COM1/COM2 port.

No.	LED name	Color	Data to Display
(d)	LINK/ACT1/2	-	OFF No connection is established.
		Green	ON Connection between the FP0H Control Unit and a device on Ethernet is established.
			Flashes Any communication processing is performed such as sending/receiving a command or response between the devices for which connection is established.
	IP MS	-	OFF The EtherNet/IP function is disabled.
		Green	ON The EtherNet/IP function is normally activated.
			Flashing This state does not exist.
		Red	ON Unrecoverable fault occurs.
	Flashing Recoverable fault occurs. (such as a setting that load factor exceeds)		
	IP NS	-	OFF The EtherNet/IP function is disabled or IP address is not established.
		Green	ON More than one connection is established.
			Flashing Connection is not established or IP address is acquired.
		Red	ON IP address duplication is detected.
Flashing This state does not exist.			
(e)	SD	Green Flashes while accessing an SD memory card.	
(f)	COM0	S	Green Flashes when data is sent via the COM0 port.
		R	Green Flashes when data is received via the COM0 port.

(Note 1) The flashing of LEDs is repeated every 1 second.

## 2.2 Power Supply Specifications

### 2.2.1 DC Power Supply

Item	Specifications
	C32T/C32P/C32ET/C32EP
Rated voltage	24 V DC
Operating voltage range	20.4 to 28.8 V DC
Momentary power off time	4 ms (20.4 V DC), 10 ms (24.0 V DC)
Fuse	Built-in (Cannot be replaced)
Insulation method	Non-isolated
Consumption current	C32T: 140 mA or less C32P: 140 mA or less C32ET: 170 mA or less C32EP: 170 mA or less

## 2.3 Input and Output Specifications

### 2.3 Input and Output Specifications

#### 2.3.1 Input Specifications

##### ■ Specifications

Item	Specifications		
Insulation method	Optical coupler		
Rated input voltage	24V DC		
Operating voltage range	21.6 to 26.4 V DC		
Rated input current	High-speed part (X0 to X7): Approx. 8 mA Low-speed part (X8 to XF): Approx. 3.5 mA		
Input points per common	16 points/common\line (Either the positive or negative of input power supply can be connected to common terminal.)		
Min. ON voltage/Min. ON current	High-speed part (X0 to X7): Approx. 19.2 V DC / 6 mA Low-speed part (X8 to XF): Approx. 19.2 V DC / 3 mA		
Max. OFF voltage/Max. OFF current	2.4 V DC / 1 mA		
Input impedance	High-speed part (X0 to X7): Approx. 3 k / Low-speed part (X8 to XF): Approx. 6.8 k		
Response time <sup>(Note 1)</sup>	OFF->ON	High-speed part (X0 to X7)	135 $\mu$ s or less (For normal input) 5 $\mu$ s or less (For high-speed counter, pulse catch and interrupt input settings)
		Low-speed part (X8 to XF)	1 ms or less (For normal input only)
	ON->OFF	Same as above.	
Operating mode indicator	LED		

(Note 1) This specification is applied when the rating is 24 V DC and the ambient temperature is 25 °C.

##### ■ Internal circuit diagram

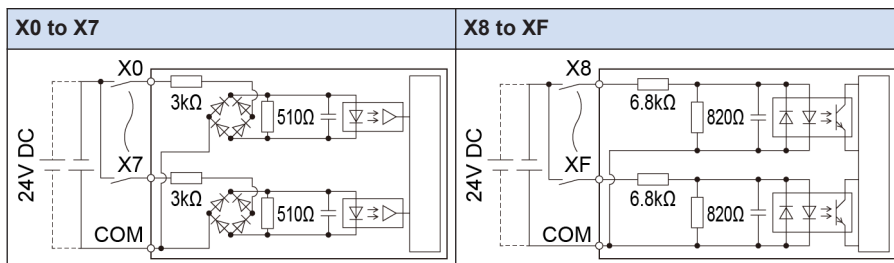

##### ■ Limitations on number of simultaneous input on points

Keep the number of points which are simultaneously on within the following range as determined by the ambient temperature.



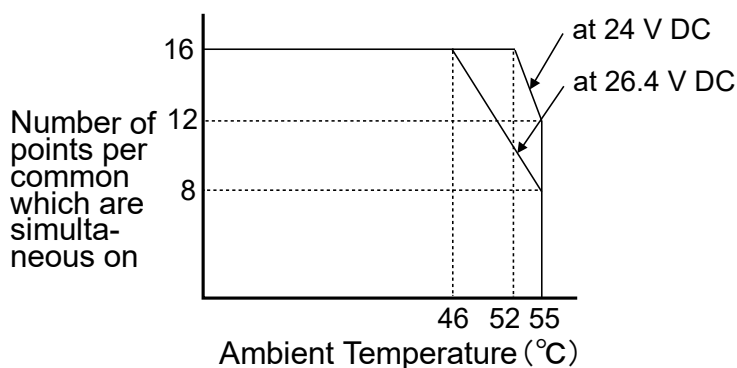

### 2.3.2 Output Specifications

#### ■ Specifications

Item	Specifications	
	C32T/C32ET	C32P/C32EP
Insulation method	Optical coupler	
Output type	NPN open drain	PNP open drain
Rated load voltage	5 to 24 V DC	24 V DC
Allowable load voltage range	4.75 to 26.4 V DC	21.6 to 26.4 V DC
Rated load current	0.3 A (Y0, Y1, Y3, Y4, Y8, Y9, YB, YC) 0.1 A (Y2, Y5, Y6, Y7, YA, YD, YE, YF)	0.3A (Y0 to YF)
Max. inrush current	High-speed part (Y0, Y1, Y3, Y4, Y8, Y9, YB, YC): 1.0 A Low-speed part (Y2, Y5, Y6, Y7, YA, YD, YE, YF): 0.5 A	
Off state leakage current	C32T/C32ET: 1 μA or less C32P/C32EP: 2 μA or less	
ON-state max. voltage drop	0.5 V DC or less	
Overcurrent protection function	Available (Automatically protected by 8 points.)	
Input points per common	16 points/common(Y0 to YF/1 common)	
Response time	OFF->ON	High-speed part (Y0, Y1, Y3, Y4, Y8, Y9, YB, YC): 2 μs or less Low-speed part (Y2, Y5, Y6, Y7, YA, YD, YE, YF): 1 ms or less
	ON->OFF	High-speed part (Y0, Y1, Y3, Y4, Y8, Y9, YB, YC): 5 μs or less Low-speed part (Y2, Y5, Y6, Y7, YA, YD, YE, YF): 1 ms or less
External power supply (for driving internal circuit)	Voltage	21.6 to 26.4 V DC
	Current	15mA or less

## 2.3 Input and Output Specifications

Item	Specifications	
	C32T/C32ET	C32P/C32EP
Surge absorber	Zener diode	
Operating mode indicator	LED	

(Note 1) This specification is applied when the ambient temperature is 25 °C.

### Internal circuit diagram

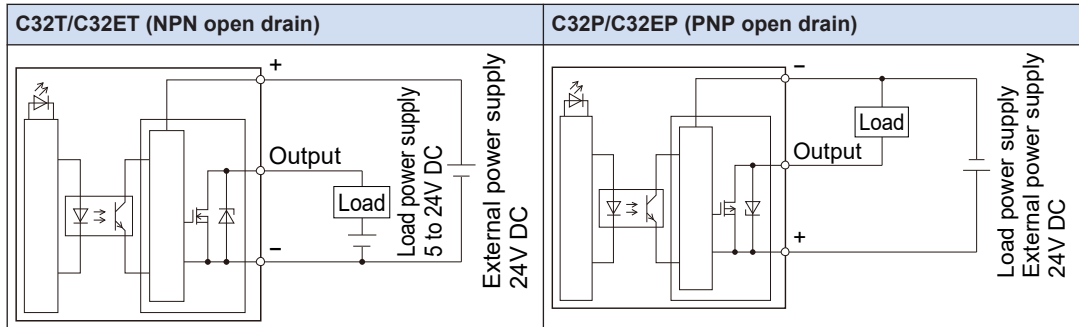

### Limitations on number of simultaneous output on points

Keep the number of points which are simultaneously on within the following range as determined by the ambient temperature.

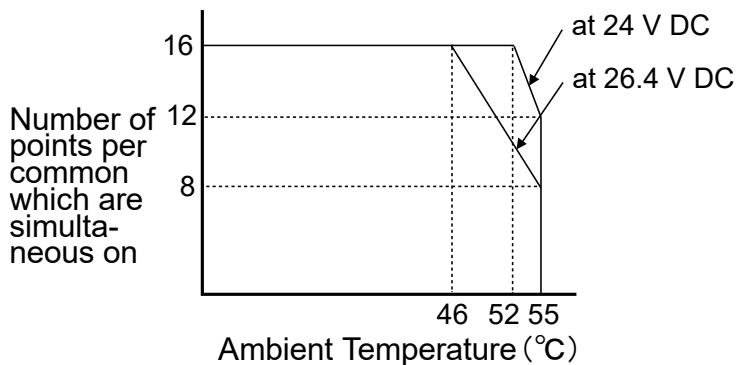

## 2.4 Terminal Layout

### Terminal layout

The input is allocated to the upper 20 pins (A1 to A10/B1 to B10) of the connector, and the output is allocated to the lower 20 pins (A11 to A20/B11 to B20).

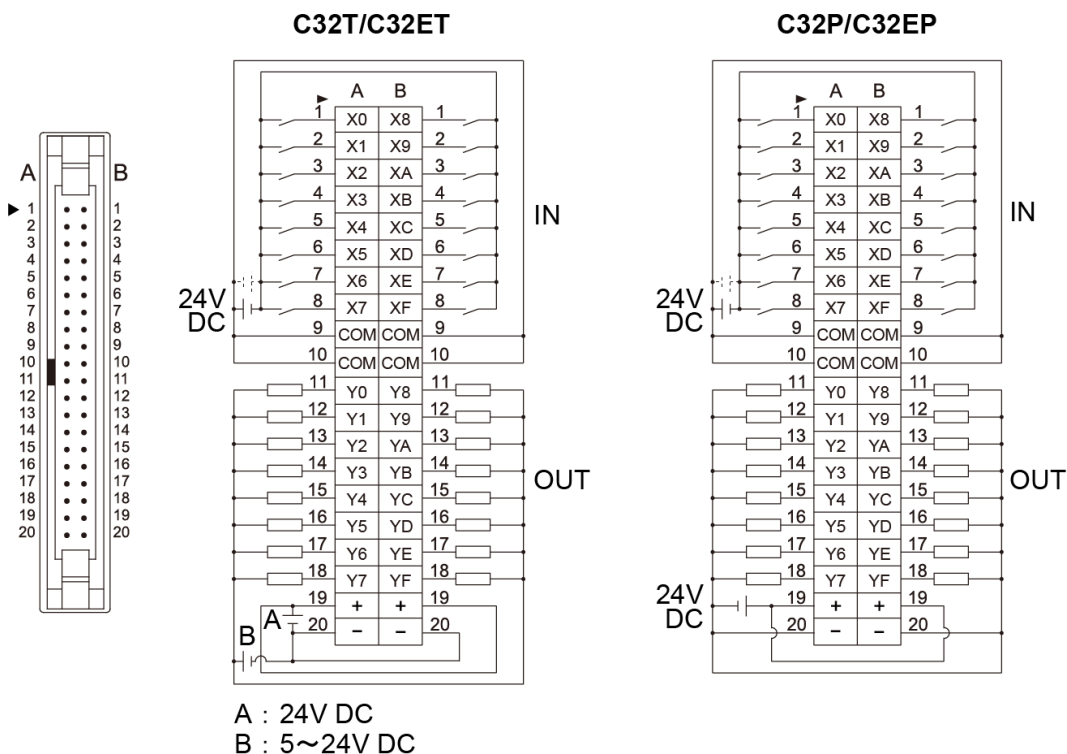

(Note 1) The four COM terminals are connected internally.

(Note 2) The two plus terminals (A19 and B19) on the output side are connected internally, and the two minus terminals (A20 and B20) are connected internally.

(Note 3) For an external power supply, use the power supply of SELV (Safety Extra-Low Voltage) and LIM (Limited Energy Circuit).

(MEMO)

# 3 Specifications of FP0H Expansion Unit

---

3.1 Names and Functions of Parts.....	3-2
3.2 Input and Output Specifications .....	3-3
3.2.1 Input specifications .....	3-3
3.2.2 Output Specifications .....	3-4
3.3 Terminal Layout.....	3-6

### 3.1 Names and Functions of Parts

#### 3.1 Names and Functions of Parts

■ AFP0HXY64D2T/AFP0HXY64D2P

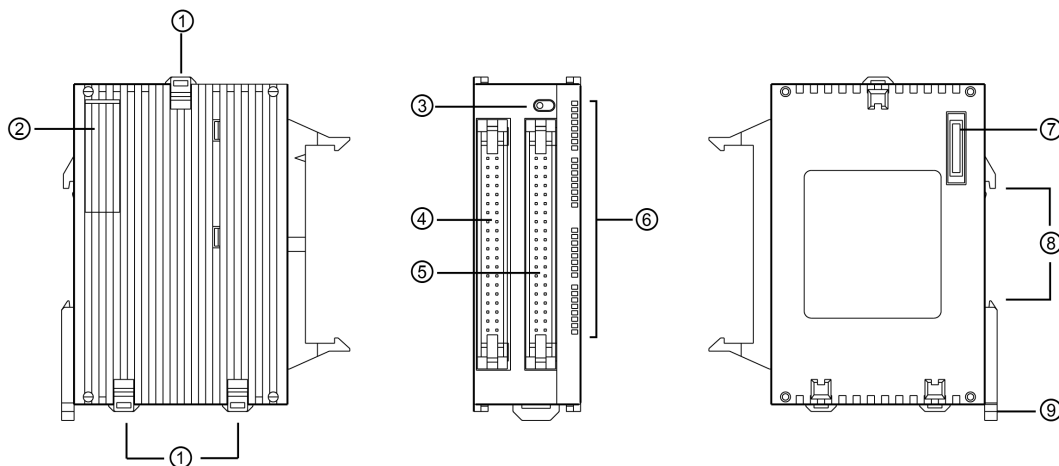

■ Names and Functions of Parts

No.	Name	Function
(1)	FP0H expansion hooks	These are the expansion hooks for FP0H Expansion Unit or FPsigma Expansion Unit.
(2)	FP0H expansion connector cover	The FP0H expansion connector (convex type) is exposed by removing the cover.
(3)	LED display selector	Switches between the input (32 points) and output (32 points) of the LED display.
(4)	Input connector (40 pins x 1)	This is used to connect an input device.
(5)	Output connector (40 pins x 1)	This is used to connect an output device.
(6)	Input and output indicator LEDs	Displays the status of the input and output.
(7)	FP0H expansion connector (Convex type)	This is used to connect the FP0H Control Unit or other FP0H expansion unit.
(8)	DIN rail installing groove	The DIN rail (35 mm wide) fits to this groove.
(9)	DIN hook	This is used to install the unit on a DIN rail.

(Note 1) The FP0 mounting plate (AFP0803/AFP0804/AFP0811) cannot be used for the FP0H Control Unit.

## 3.2 Input and Output Specifications

### 3.2.1 Input specifications

#### ■ Specifications

Item	Specifications	
Insulation method	Optical coupler	
Rated input voltage	24V DC	
Operating voltage range	21.6 to 26.4 V DC	
Rated input current	Approx. 3.5 mA	
Input points per common	32 points/common (Either the positive or negative of input power supply can be connected to common terminal.)	
Min. ON voltage/Min. ON current	19.2V DC / 3 mA	
Max. OFF voltage/Max. OFF current	2.4 V DC / 1 mA	
Input impedance	Approx. 6.8 k $\Omega$	
Response time	OFF->ON	0.2 ms or less
	ON->OFF	0.3 ms or less
Operating mode indicator	LED	

(Note 1) This specification is applied when the rating is 24 V DC and the ambient temperature is 25 °C.

#### ■ Internal circuit diagram

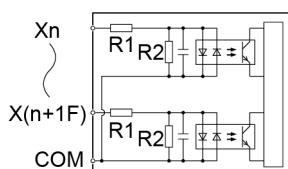

X0-XF R1 = 6.8 k $\Omega$ , R2 = 820 k $\Omega$

#### ■ Limitations on number of simultaneous input on points

Keep the number of points which are simultaneously on within the following range as determined by the ambient temperature.

## 3.2 Input and Output Specifications

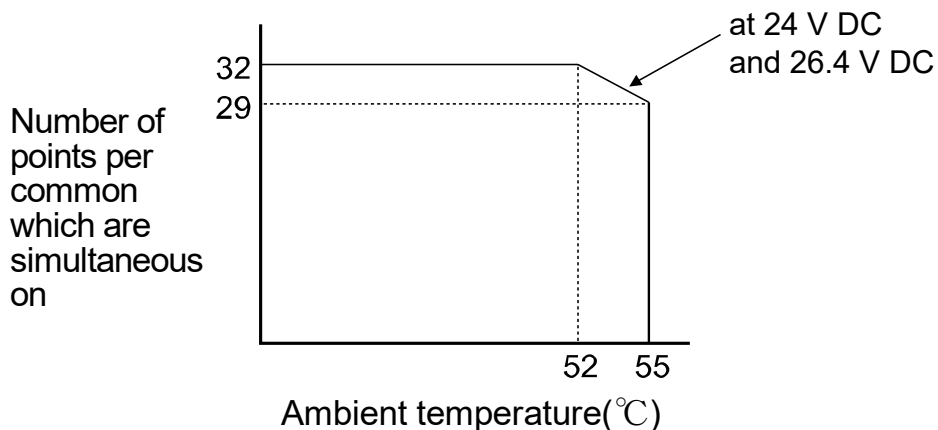

### 3.2.2 Output Specifications

#### ■ Specifications

Item	Specifications	
	AFP0HXY64D2T	AFP0HXY64D2P
Insulation method	Optical coupler	
Output type	NPN open collector	PNP open collector
Rated load voltage	5 to 24 V DC	24 V DC
Allowable load voltage range	4.75 to 26.4 V DC	21.6 to 26.4 V DC
Rated load current	0.1 A	
Max. inrush current	0.5 A	
Off state leakage current	100 $\mu$ A or less	
ON-state max. voltage drop	0.5 V DC or less	
Input points per common	16 points/common	
Response time	OFF->ON	0.2 ms or less
	ON->OFF	0.2 ms or less
External power supply (for driving internal circuit)	Voltage	21.6 V DC to 26.4 V DC
	Current	15 mA or less
Surge absorber	Zener diode	
Short-circuit protection	Thermal protection	
Operating mode indicator	LED	

(Note 1) This specification is applied when the ambient temperature is 25 °C.



### Internal circuit diagram

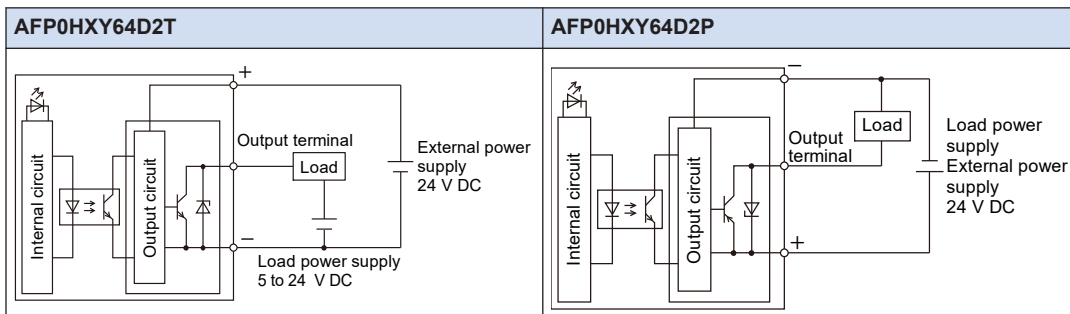

### Limitations on number of simultaneous output on points

Keep the number of points which are simultaneously on within the following range as determined by the ambient temperature.

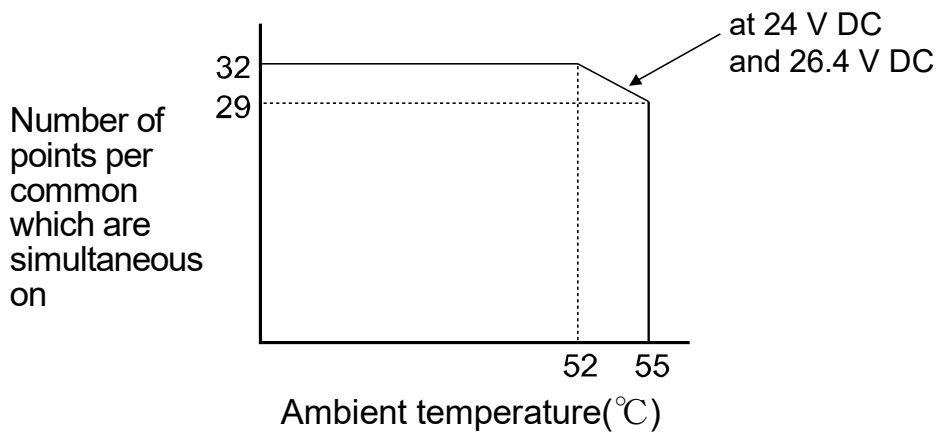

### 3.3 Terminal Layout

#### 3.3 Terminal Layout



- The I/O connectors of "FP0H Control Unit" and "FP0H Expansion I/O Unit" are both 40 pins, however, the terminal layouts are different.

#### ■ AFP0HXY64D2T Terminal layout

The input is allocated to the 40 pins of the left connector, and the output is allocated to the 40 pins of the right connector.

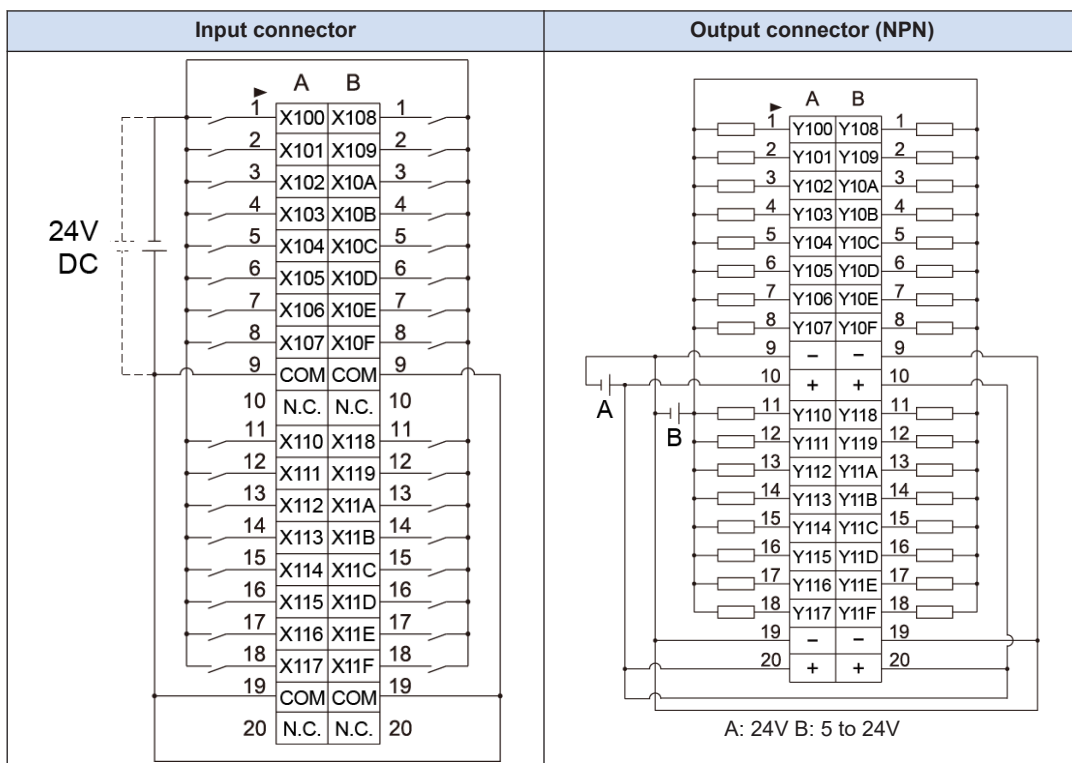

- (Note 1) COM terminals in the same connector are connected within the unit.
- (Note 2) Although COM terminals in the same connector are connected within the unit, also connect them externally.
- (Note 3) The voltages of the external power supply of the output circuit should be 24 V, and the voltage of the power supply for the load circuit should be within the range of 5 to 24 V.
- (Note 4) The I/O numbers (from X100, from Y100) in the above figure show the case of the left expansion 1. Those numbers vary according to the installation position of the expansion unit. Refer to "4 Allocation of I/O Numbers".

#### ■ AFP0HXY64D2P Terminal layout

The input is allocated to the 40 pins of the left connector, and the output is allocated to the 40 pins of the right connector.

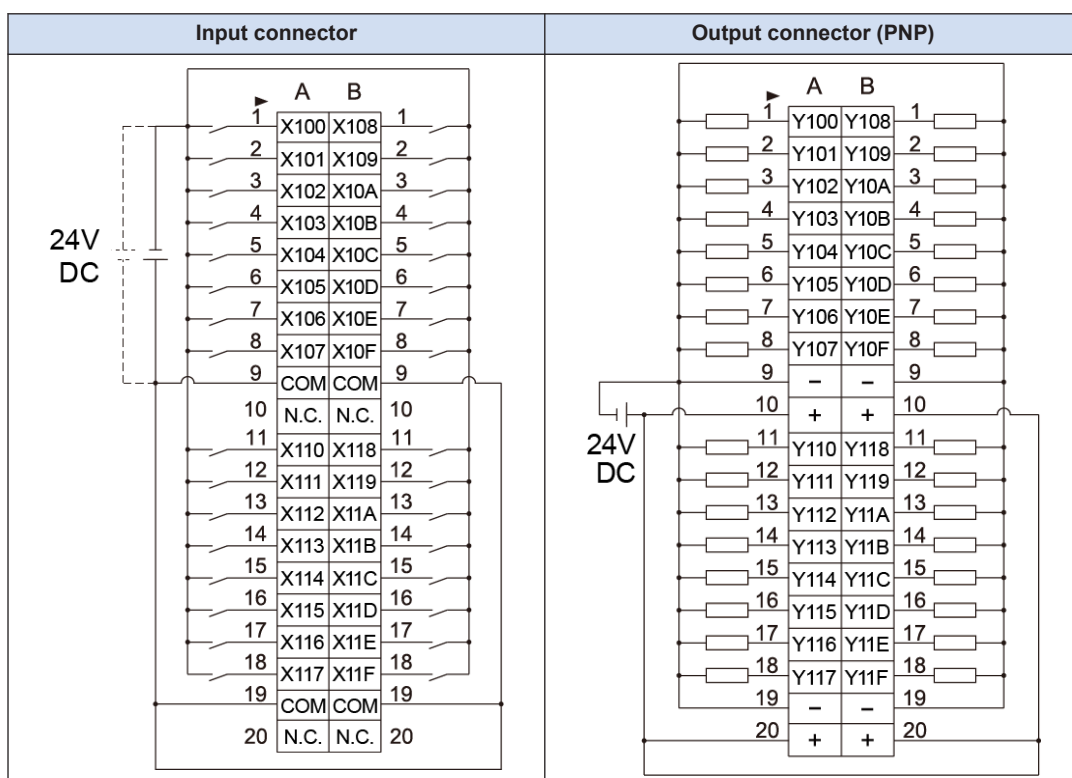

- (Note 1) COM terminals in the same connector are connected within the unit.
- (Note 2) Although COM terminals in the same connector are connected within the unit, also connect them externally.
- (Note 3) The voltage of the external power supply for the output circuit and the voltage of the power supply for the load circuit should be 24 V.
- (Note 4) The I/O numbers (from X100, from Y100) in the above figure show the case of the left expansion 1. Those numbers vary according to the installation position of the expansion unit. Refer to "4 Allocation of I/O Numbers".

## REFERENCE

### 4 Allocation of I/O Numbers

(MEMO)

# 4 Allocation of I/O Numbers

---

4.1 Basics of I/O Allocation .....	4-2
4.1.1 How to Count I/O Numbers .....	4-2
4.1.2 Concept of I/O Number Allocation .....	4-2
4.2 List of I/O Numbers for Each Unit .....	4-5
4.2.1 FP0H Control Unit .....	4-5
4.2.2 FP0H/FPsigma Expansion Units .....	4-5
4.2.3 FP0/FP0R Expansion Units .....	4-5
4.2.4 Types and I/O Numbers of FP0R Expansion Units .....	4-5
4.2.5 Types and I/O Numbers of FP0 Intelligent Units .....	4-7

## 4.1 Basics of I/O Allocation

---

### 4.1 Basics of I/O Allocation

#### 4.1.1 How to Count I/O Numbers

##### ■ How to count and express I/O numbers

- Since I/O number are handled in units of 16 points, they are expressed as a combination of a device type code and the lowest-digit of a decimal or hexadecimal number.
- In the case of external inputs, they are expressed as X0 to X9 and XA to XF. In the case of external outputs, they are expressed as Y0 to Y9 and YA to YF.

<Decimal>                      1 2 7 F                      <Hexadecimal>  
0, 1, 2, 3 ..... 9                      0, 1, 2, 3 ..... 9, A, B ..... F

#### 4.1.2 Concept of I/O Number Allocation

##### ■ I/O numbers of Control Unit

Fixed areas are allocated to I/O numbers.

##### ■ I/O numbers of Expansion Unit

The starting number allocated to each expansion unit varies according to the installation position.

##### ■ I/O numbers allocated to Function Cassette

Fixed areas are allocated to I/O numbers according to the installation position.

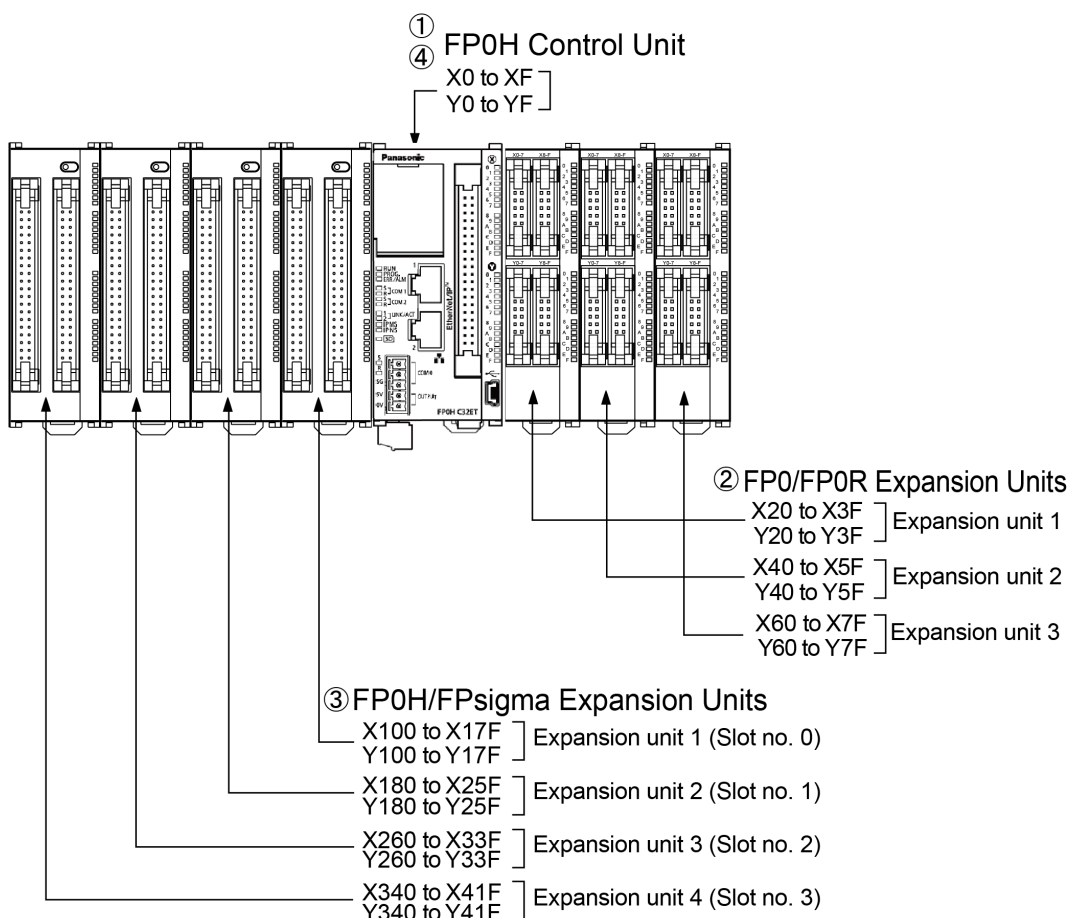

■ List of I/O numbers

Unit type and installation position		I/O number <sup>(Note 1)</sup>				
		Input		Output		
(1)	Control unit	X0 to -XF	WX0 to WX0	Y0 to YF	WY0 to WY0	
(2)	FP0/FP0R Expansion Unit	1st unit	X20 to X3F	WX2 to WX3	Y20 to Y3F	WY2 to WY3
		2nd unit	X40 to X5F	WX4 to WX5	Y40 to Y5F	WY4 to WY5
		3rd unit	X60 to X7F	WX6 to WX7	Y60 to Y7F	WY6 to WY7
(3)	FP0H/FPsigma Expansion Units <sup>(Note 2)</sup>	1st unit	X100 to X17F	WX10 to WX17	Y100 to Y17F	WY10 to WY17
		2nd unit	X180 to X25F	WX18 to WX25	Y180 to Y25F	WY18 to WY25
		3rd unit	X260 to X33F	WX26 to WX33	Y260 to Y33F	WY26 to WY33
		4th unit	X340 to X41F	WX34 to WX41	Y340 to Y41F	WY34 to WY41
(4)	For positioning control of FP0H Control Unit	X800 to X89F	WX80 to WX89	Y800 to Y89F	WY80 to WY89	

## 4.1 Basics of I/O Allocation

---

- (Note 1) The ranges of the I/O numbers which are actually used vary according to the types of cassettes and expansion units.
- (Note 2) The number of occupied I/O points for the FP0H/FPsigma Positioning Unit is the same as that for the FP0H/FPsigma Positioning Unit RTEK.



## 4.2 List of I/O Numbers for Each Unit

### 4.2.1 FP0H Control Unit

#### ■ List of I/O numbers

Unit type	I/O number	Number of allocation
FP0H Control Unit	X0 to XF	Input (16 points)
	Y0 to YF	Output (16 points)

### 4.2.2 FP0H/FPsigma Expansion Units

They are installed to the left side of the FP0H.

#### ■ List of I/O numbers

Unit Type	Input	Output
1st expansion unit	X100 to X17F (WX10 to WX17)	Y100 to Y17F (WY10 to WY17)
2nd expansion unit	X180 to X25F (WX18 to WX25)	Y180 to Y25F (WY18 to WY25)
3rd expansion unit	X260 to X33F (WX26 to WX33)	Y260 to Y33F (WY26 to WY33)
4th expansion unit	X340 to X41F (WX34 to WX41)	Y340 to Y41F (WY34 to WY41)

(Note 1) The number of occupied I/O points for the FP0H/FPsigma Positioning Unit is the same as that for the FP0H/FPsigma Positioning Unit RTEK.

### 4.2.3 FP0/FP0R Expansion Units

They are installed to the right side of the FP0H.

#### ■ List of I/O numbers

Unit Type	Input	Output
1st expansion unit	X20 to X3F (WX2 to WX3)	Y20 to Y3F (WY2 to WY3)
2nd expansion unit	X40 to X5F (WX4 to WX5)	Y40 to Y5F (WY4 to WY5)
3rd expansion unit	X60 to X7F (WX6 to WX7)	Y60 to Y7F (WY6 to WY7)

### 4.2.4 Types and I/O Numbers of FP0R Expansion Units

The I/O numbers for each FP0R Expansion Unit are as follows.

## 4.2 List of I/O Numbers for Each Unit

### ■ List of I/O numbers

Unit Type		Number of allocations	Expansion unit 1	Expansion unit 2	Expansion unit 3
FP0R Expansion unit	AFP0RE8X	Input (8 points)	X20 to X27	X40 to X47	X60 to X67
	AFP0RE8R	Input (4 points)	X20 to X23	X40 to X43	X60 to X63
		Output (4 points)	Y20 to Y23	Y40 to Y43	Y60 to Y63
	AFP0E8YT/P AFP0RE8YR	Output (8 points)	Y20 to Y27	Y40 to Y47	Y60 to Y67
	AFP0RE16X	Input (16 points)	X20 to X2F	X40 to X4F	X60 to X6F
	AFP0RE16R AFP0RE16T/P	Input (8 points)	X20 to X27	X40 to X47	X60 to X67
		Output (8 points)	X20 to X27	X40 to X47	X60 to X67
	AFP0RE16YT/P	Output (16 points)	X20 to X2F	X40 to X4F	X60 to X6F
AFP0RE32T/P	Input (16 points)	X20 to X2F	X40 to X4F	X60 to X6F	
	Output (16 points)	X20 to X2F	X40 to X4F	X60 to X6F	
FP0R Analog Input Unit	AFP0RAD4 (Note 1) AFP0RAD8	Input (16 points) CH0, 2, 4, 6	WX2 (X20 to X2F)	WX4 (X40 to X4F)	WX6 (X60 to X6F)
		Input (16 points) CH1, 3, 5, 7	WX3 (X30 to X3F)	WX5 (X50 to X5F)	WX7 (X70 to X7F)
		Output (16 points) Range setting	WY2 (Y20 to Y2F)	WY4 (Y40 to Y4F)	WY6 (Y60 to Y6F)
		Output (16 points) Averaging setting	WY3 (Y30 to Y3F)	WY5 (Y50 to Y5F)	WY7 (Y70 to Y7F)
FP0R Analog Output Unit	AFP0RDA4	Input (32 points) Status	WX2 (X20 to X2F)	WX4 (X40 to X4F)	WX6 (X60 to X6F)
			WX3 (X30 to X3F)	WX5 (X50 to X5F)	WX7 (X70 to X7F)
		Output (16 points) CH0, 2(Note 2)	WY2 (Y20 to Y2F)	WY4 (Y40 to Y4F)	WY6 (Y60 to Y6F)
		Output (16 points) CH1, 3(Note 2)	WY3 (Y30 to Y3F)	WY5 (Y50 to Y5F)	WY7 (Y70 to Y7F)
FP0R Analog I/O Unit	AFP0RA21 (Note 3) AFP0RA42	Input (16 points) CH0, 2	WX2 (X20 to X2F)	WX4 (X40 to X4F)	WX6 (X60 to X6F)
		Input (16 points) CH1, 3	WX3 (X30 to X3F)	WX5 (X50 to X5F)	WX7 (X70 to X7F)
		Output (16 points)	WY2 (Y20 to Y2F)	WY4 (Y40 to Y4F)	WY6 (Y60 to Y6F)

## 4.2 List of I/O Numbers for Each Unit

Unit Type		Number of allocations	Expansion unit 1	Expansion unit 2	Expansion unit 3
		CH0 <sup>(Note 4)</sup>			
		Output (16 points) CH1 <sup>(Note 4)</sup>	WY3 (Y30 to Y3F)	WY5 (Y50 to Y5F)	WY7 (Y70 to Y7F)

(Note 1) For AFP0RAD4, data of CH0 to CH3 is handled.

(Note 2) In the 14-bit mode, it can be used for switching the output range.

(Note 3) For AFP0RA21, data of input CH0/CH1 and output CH0 is handled.

(Note 4) In the 14-bit mode, it can be used for switching the input and output ranges, and setting the averaging for input.

### 4.2.5 Types and I/O Numbers of FP0 Intelligent Units

The I/O numbers for each FP0 Intelligent Unit are as follows.

#### ■ List of I/O numbers

Unit Type		Number of allocations	Expansion unit 1	Expansion unit 2	Expansion unit 3
FP0 Thermocouple Unit	FP0-TC4	Input (16 points) CH0, 2, 4, 6	WX2 (X20 to X2F)	WX4 (X40 to X4F)	WX6 (X60 to X6F)
	FP0-TC8	Input (16 points) CH1, 3, 5, 7	WX3 (X30 to X3F)	WX5 (X50 to X5F)	WX7 (X70 to X7F)

(Note 1) The data of each channel of FP0 Thermocouple Unit (FP0-TC4/FP0-TC8) is read or written by a user program including a conversion data switching flag.

(Note 2) Regarding FP0 CC-Link slave unit, please refer to the exclusive manual. (The starting address should be replaced.)

(MEMO)

# 5 Installation and Wiring

---

5.1 Installation.....	5-2
5.1.1 Installation Environment and Space .....	5-2
5.2 Installation of Backup Battery .....	5-4
5.2.1 Installation of Backup Battery .....	5-4
5.3 Installation of Extension (Communication) Cassette .....	5-5
5.3.1 Precautions When Installing Extension (Communication) Cassette .....	5-5
5.3.2 Installing Extension (Communication) Cassette .....	5-5
5.4 Connection of Expansion Unit.....	5-6
5.4.1 Connection of FP0/FP0R Expansion Unit.....	5-6
5.4.2 Connection of FP0H/FPsigma Expansion Unit .....	5-6
5.5 Installation.....	5-8
5.5.1 Attachment to DIN rail .....	5-8
5.5.2 Removal from DIN rail.....	5-8
5.6 Wiring of Power Supply.....	5-9
5.6.1 Common Precautions .....	5-9
5.6.2 Power Supply of FP0H Control Unit / FP0/FP0R Expansion Unit....	5-10
5.6.3 Grounding .....	5-11
5.7 Wiring of Input and Output.....	5-13
5.7.1 Precautions on Wirings of Input and Output .....	5-13
5.7.2 Input Wiring.....	5-13
5.7.3 Output Wiring .....	5-14
5.8 Connection Using the Discrete-wire Connector .....	5-16
5.8.1 Specifications of the Discrete-wire Connector .....	5-16
5.8.2 Wiring the Discrete-wire Connector .....	5-17
5.9 Safety Measures .....	5-20
5.9.1 Safety Measures .....	5-20
5.9.2 Instantaneous Power Failure .....	5-20
5.9.3 Watchdog Timer .....	5-20

## 5.1 Installation

---

### 5.1 Installation

#### 5.1.1 Installation Environment and Space

##### ■ Installation environment

- Operating environment (Use the unit within the range of the general specifications when installing) Intended for use within the following environment:
  - Surrounding air temperature: 0 to 55 °C
  - Surrounding air humidity: 10 to 95% RH (at 25 °C and non-condensing)
  - Pollution degree: 2
  - Altitude: 2000 m above sea level or lower
  - Overvoltage category: II or lower
  - Installation location: In a control panel
- Do not use it in the following environments.
  - Direct sunlight
  - Sudden temperature changes causing condensation.
  - Inflammable or corrosive gas.
  - Excessive airborne dust, metal particles or saline matter.
  - Benzine, paint thinner, alcohol or other organic solvents or strong alkaline solutions such as ammonia or caustic soda.
  - Direct vibration, shock or direct drop of water.
  - Influence from power transmission lines, high voltage equipment, power cables, power equipment, radio transmitters, or any other equipment that would generate high switching surges. (100 mm or more)

##### ■ Static electricity

- Before touching the unit, always touch a grounded piece of metal in order to discharge static electricity.
- Do not touch connector pins directly.

##### ■ Measures regarding heat discharge

- As countermeasures against heat radiation, install the unit in the direction as shown below.

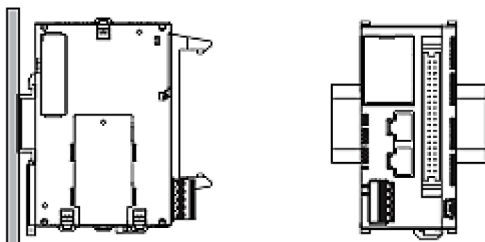

- Do not install the unit stacked up, horizontally or upside down. Doing so will prevent proper cooling of the unit and cause overheating inside.

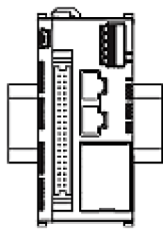

Installed upside  
down

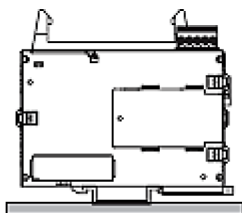

Installed so that PLC is  
horizontal.

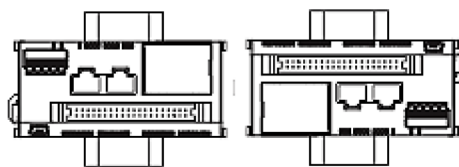

Installed so that DIN rail is vertical.

- Do not install the unit above devices which generate heat such as heaters, transformers or large scale resistors.

#### ■ Installation space

- Leave at least 50 mm or space between the wiring ducts of the unit and other devices to allow heat radiation and unit replacement.
- In order to eliminate any effects from noise emission, power wires and electromagnetic devices should be kept at least 100 mm away from the surfaces of the unit. When installing the unit behind the doors of the control board, be especially careful to secure clearances as above.
- Secure a space for connecting a cable for a programming tool.

## 5.2 Installation of Backup Battery

### 5.2 Installation of Backup Battery

#### 5.2.1 Installation of Backup Battery

The procedure for installing the backup battery is as follows.

#### **i** Info.

- The backup battery is used for using the clock/calendar function and extending the backup area of the operation memory.
- For the details of the function and lifetime of backup battery, and the setting method of hold area, refer to "7 Memory Backup".

#### **1 2** Procedure

1. Open the battery cover.
2. Insert the backup battery in the battery holder.
3. Connect the battery connector.
4. Close the battery cover.

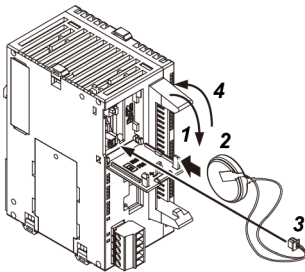

Open the lever part for removing the backup battery.

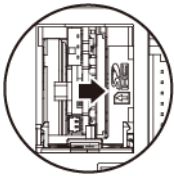

Do not apply an excessive force to the card cover when opening or closing it or when the cover is left open. Otherwise, the cover attachment part will be deformed to cause malfunction in the cover recognition switch mounted inside the product.

#### REFERENCE

7 Memory Backup



### 5.3 Installation of Extension (Communication) Cassette

#### 5.3.1 Precautions When Installing Extension (Communication) Cassette



- The installation must be carried out when the power supply is off. If the power supply is on, it may cause faults.
- Do not touch the back side of the extension (communication) cassette and the connector. The parts such as IC, etc. may be damaged by static electricity.

#### 5.3.2 Installing Extension (Communication) Cassette

One communication cassette can be attached to the control unit.

**1 2**

#### Procedure

1. Remove the cover on the side face of the unit with a slotted screwdriver. There are four tabs.

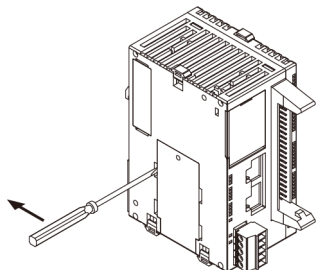

2. Install an arbitrary communication cassette.

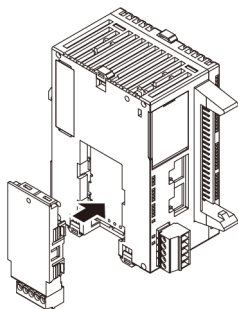

## 5.4 Connection of Expansion Unit

### 5.4 Connection of Expansion Unit

#### 5.4.1 Connection of FP0/FP0R Expansion Unit

- The FP0/FP0R Expansion Units (expansion unit and intelligent unit) are connected on the right side of the FP0H Control Unit.
- Unit expansion is done using the right-side connector for FP0R expansion and expansion hook on the side of the unit.

#### 1 2 Procedure

1. Raise the expansion hooks on the top and bottom sides of the unit with a screwdriver.
2. Align the pins and holes at the four corners of the control unit and expansion unit and fit. Insert the pins into the holes so that there is no gap between the units.

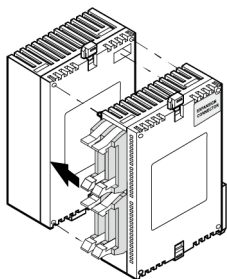

3. "Step 1" Press down the expansion hooks raised in <<TAG: step 1>> to secure the unit.

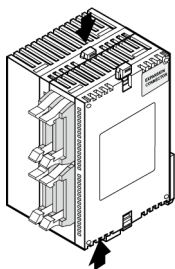

#### 5.4.2 Connection of FP0H/FPsigma Expansion Unit

- The dedicated expansion unit for FP0H/FPsigma (including intelligent units) is expanded by connecting to the left side of the control unit,
- Unit expansion is done using the left-side connector for expansion and expansion hook on the side of the unit.

#### 1 2 Procedure

1. Remove the cover on the left side face of the unit.

Expose the left-side connector for expansion.

2. Raise the expansion hooks on the top and bottom sides of the unit with a screwdriver.

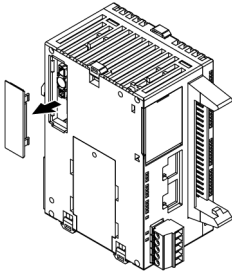

3. Align the pins and holes at the four corners of the control unit and expansion unit and fit. Insert the pins into the holes so that there is no gap between the units.

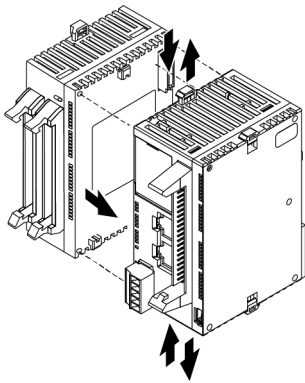

4. "Step 2" Press down the expansion hooks raised in step 2 to secure the unit.

## 5.5 Installation

### 5.5 Installation

#### 5.5.1 Attachment to DIN rail

##### 1 2 Procedure

1. Fully pull out the DIN rail attachment lever on the back of the unit.
2. Fit the top of the unit attachment part into the DIN rail.
3. While pressing down the unit attachment part onto the DIN rail, fit the bottom of the unit attachment part into the DIN rail.
4. Push up the DIN rail attachment lever on the back of the unit until it "clicks" to lock.

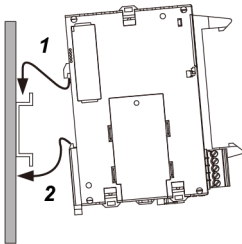

#### 5.5.2 Removal from DIN rail

##### 1 2 Procedure

1. Fully pull out the DIN rail attachment lever on the back of the unit.
2. Pull the bottom of the unit forward.
3. While pulling up the unit, remove it from the DIN rail.

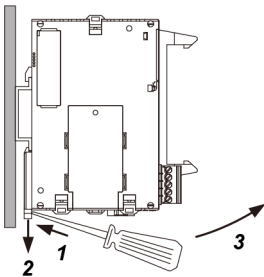

## 5.6 Wiring of Power Supply

### 5.6.1 Common Precautions

#### ■ Selection of power supply

- Use a low noise power supply.
- The inherent noise resistance is sufficient for the noise superimposed on the power wires, however, the noise can be attenuated further by using the insulation transformer or insulated power supply.

#### ■ Isolation of power supply systems

Isolate the wiring systems to the units, input/output devices, and mechanical power apparatus.

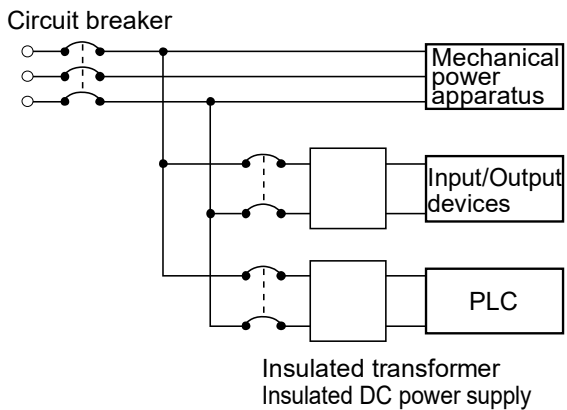

#### ■ Power supply sequence

- The power supply sequence should be set up so that the power supply of the PLC turns off before the power supplies for input and output.
- If the power supplies for input and output turns off before the power to the PLC, the control unit will detect the input fluctuations and may begin an unscheduled operation.

## 5.6 Wiring of Power Supply

### 5.6.2 Power Supply of FP0H Control Unit / FP0/FP0R Expansion Unit

#### ■ Wiring the Power supply

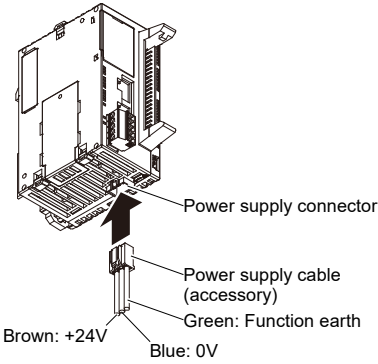
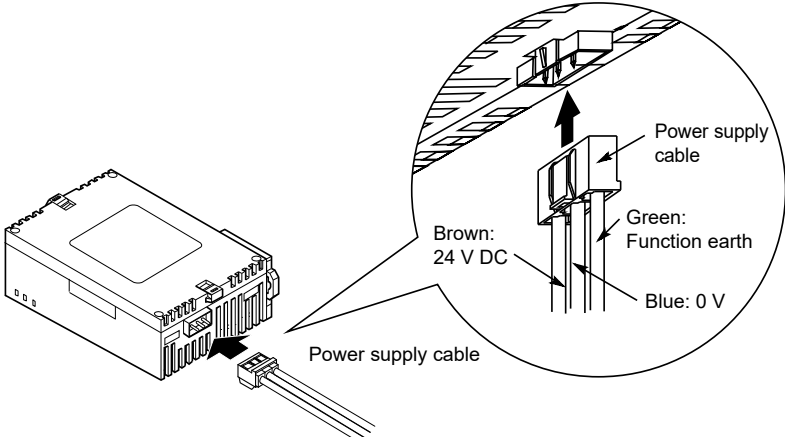
Unit	Wiring diagram
FP0H Control Unit	 <p>Power supply connector</p> <p>Power supply cable (accessory)</p> <p>Brown: +24V</p> <p>Green: Function earth</p> <p>Blue: 0V</p>
FP0R Expansion Unit FP0R Intelligent Unit	 <p>Power supply cable</p> <p>Brown: 24 V DC</p> <p>Green: Function earth</p> <p>Blue: 0 V</p>

#### ■ Selection of power supply

- To protect the system against erroneous voltage from the power supply line, use an insulated power supply with an internal protective circuit (power supply that reinforced insulation or double insulation has been made).
- The regulator on the unit is a non-insulated type.

#### ■ Power supply voltage

- Confirm that the voltage of the connected power supply is within the allowable range.

Rated input voltage	Allowable voltage range
24V DC	20.4 to 28.8 V DC

#### ■ Power supply cable

- Use the power supply cable (Part no.:AFPG805) that comes with the unit to connect the power supply.

Brown: 24 V DC, Blue: 0 V, Green: Function earth

- Also, twist the power supply cables to minimize adverse effects from noise.

■ **Power supply sequence**

- Turn on the power supply of the expansion unit before the system power to the FP0H Control Unit.
- The power supply sequence should be set up so that the system power to the FP0H Control Unit and the power to the expansion unit turns off before the power supplies for input and output. If the power supplies for input and output turns off before them, the control unit will detect the input fluctuations and may begin an unscheduled operation.

Operation	Power supply sequence
When turning ON	Power supply for input and output Power supply for expansion unit Power supply for FP0H
When turning OFF	Power supply for FP0H Power supply for expansion unit Power supply for input and output

**5.6.3 Grounding**

■ **Use dedicated grounding**

- The grounding connection should have a resistance of less than 100.
- The point of grounding should be as close to the PLC unit as possible. The ground wire should be as short as possible.
- Sharing the ground with another device may have an adverse effect. Therefore, be sure that grounding is dedicated.

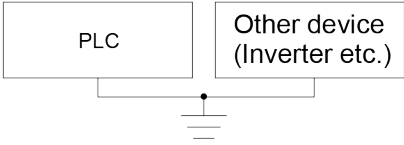
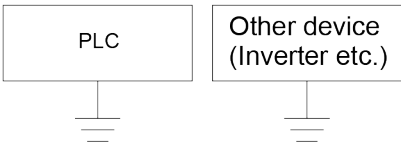

## 5.6 Wiring of Power Supply

- **Conversely, depending on your environment, grounding may cause a problem.**

Since the power supply line of the FP0/FP0R Expansion Unit is connected to the function earth through a varistor, if there is an irregular potential between the power supply line and earth, the varistor may be shorted.

As for the FP0H Control Unit, since its power supply line is connected to the function earth through a high-voltage capacitor, it is no problem.

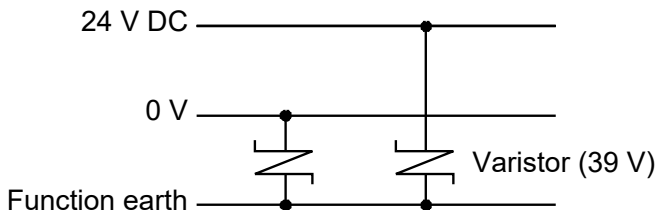

### FP0/FP0R Expansion unit power supply line

- **Do not ground the function earth when grounding a plus (+) terminal of the power.**



When grounding the plus terminal of power supply, provide a dedicated power supply for the PLC and do not ground the plus terminal of the PLC power supply. In some computers, the SG terminal of the internal circuit and outer shell are connected. Also, because the power supply circuit of the FP0H is not isolated, if the plus terminal of the power supply is grounded, short circuit will occur in the power supply and it will lead to the damage to the unit.

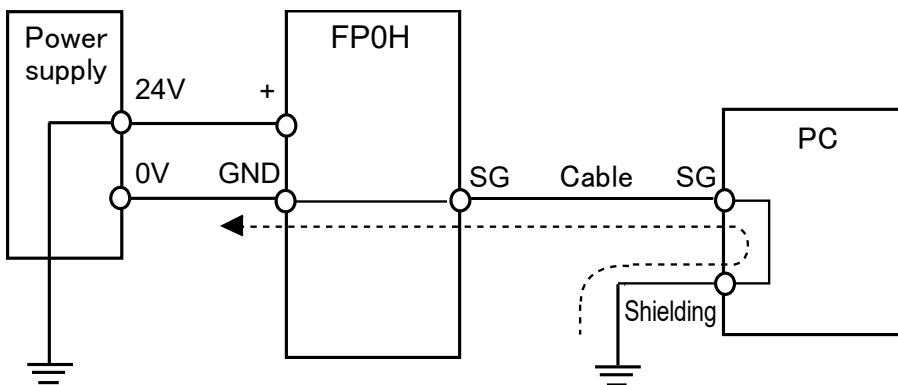



## 5.7 Wiring of Input and Output

### 5.7.1 Precautions on Wirings of Input and Output

#### ■ Wiring position

Arrange the wiring so that the input and output wiring are separated, and these wirings are separated from the power wiring, as much as possible. Do not route them through the same duct or tie them in a bundle. Separate the input/output wires from the power and high voltage wires by at least 100 mm.

#### ■ Selection of wires

Be sure to select the thickness (dia.) of the input and output wires while taking into consideration the required current capacity.

#### ■ Power supply

Wiring should be carried out after the power supply to the PLC was turned off. Also turn of the power supply when the control unit, expansion units and various cassettes are connected. If they are connected during the power supply is on, it may cause the fault or malfunction.

### 5.7.2 Input Wiring

#### ■ Connection of photoelectric sensor and proximity sensor

##### Relay output type

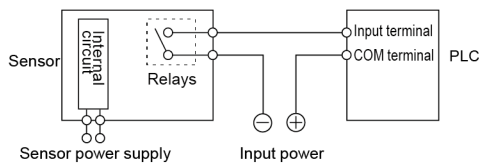

##### NPN open collector output type

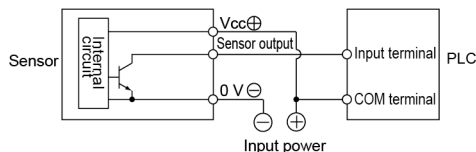

##### Voltage output type

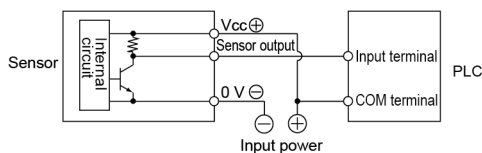

## 5.7 Wiring of Input and Output

### Two-wire output type

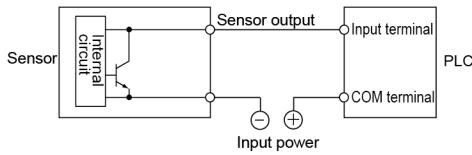

#### ■ Precaution when using LED-equipped lead switch

When a LED is connected in series to an input contact such as LED-equipped lead switch, make sure that the voltage applied to the PLC input terminal is greater than the ON voltage. In particular, take care when connecting a number of switches in series.

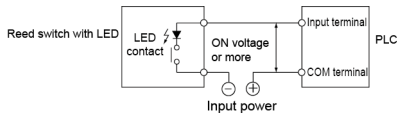

#### ■ Precaution when using two-wire type sensor

If the input of PLC does not turn off because of leakage current from the two-wire type sensor “photoelectric sensor or proximity sensor”, the use of a bleeder resistor is recommended, as shown below.

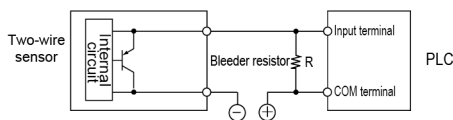

#### ■ Precaution when using LED-equipped limit switch

If the input of PLC does not turn off because of leakage current from the LED-equipped limit switch, the use of a bleeder resistor is recommended, as shown below.

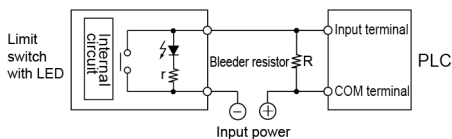

### 5.7.3 Output Wiring

#### ■ Protective circuit for inductive loads

With an inductive load, a protective circuit should be installed in parallel with the load.

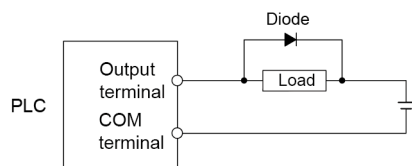

Diode Reverse voltage Higher than 3 times the rated load voltage  
Average rectified current Greater than the load current

■ Precautions when using capacitive loads

When connecting loads with large in-rush currents, to minimize their effect, connect a protection circuit as shown below.

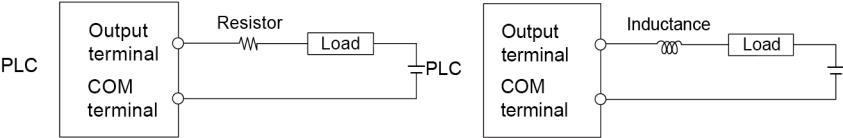

## 5.8 Connection Using the Discrete-wire Connector

### 5.8 Connection Using the Discrete-wire Connector

#### 5.8.1 Specifications of the Discrete-wire Connector

This is a connector that allows loose wires to be connected without removing the wire's insulation. Use a special tool for wire connection.

##### Discrete-wire connector (40P)

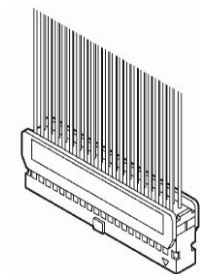

##### ■ AFP2801 Discrete-wire Connector (Purchase separately)

Manufacturer	Composition of parts	Quantity (2 sets)
Panasonic (AFP2801)	Housing (40P)	1 pc.
	Semi-cover (40P)	2 pcs.
	Contact (For AWG22 and AWG24) 5 pins	8 pcs.

##### ■ Compatible wires (stranded wire)

Size	Nominal cross-sectional area	Insulation thickness	Rated current
AWG22	0.3 mm <sup>2</sup>	Φ1.5 to Φ1.1	3 A
AWG24	0.2 mm <sup>2</sup>		

##### ■ Dedicated crimping tool

Manufacturer	Product No.
Panasonic	AXY52000FP

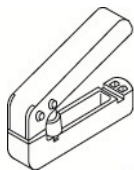

### 5.8.2 Wiring the Discrete-wire Connector



- When performing wiring work, refer to the instruction manual of the crimping tool in order to prevent faulty wiring.

**1 2**

#### Procedure

1. Bend and break the contact, and set it in the crimping tool.

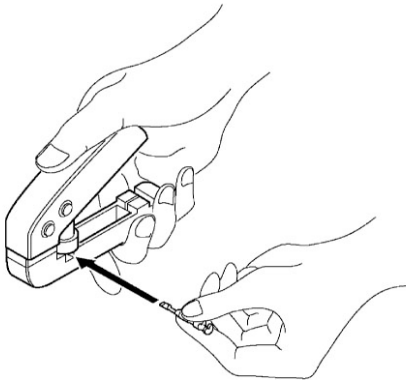

2. Insert the wire without removing its insulation until it stops, and lightly grip the crimping tool.

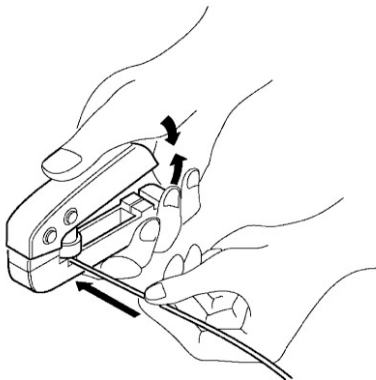

3. The contact appears as shown below after it is crimped. Confirm the following two points.
  1. The wire must be embraced inside the clamped part.
  2. The wire must be inserted to the end.

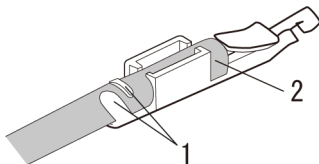

4. Insert the wire with the contact into the housing.

## 5.8 Connection Using the Discrete-wire Connector

---

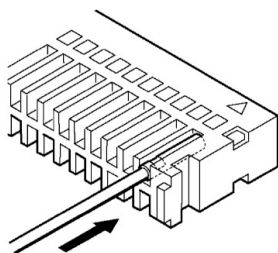

5. When all the wires have been inserted, fit the semi-cover into place.

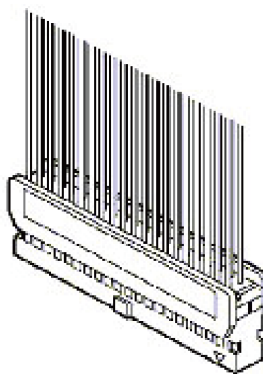
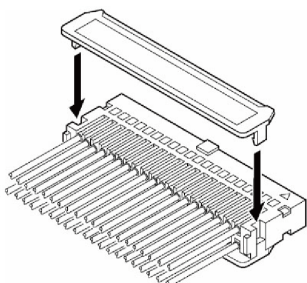

### **i** Info.

- If there is a wiring mistake or the wire is incorrectly press-fit, use the crimping tool to remove the contact.
  1. Set the pin of the crimping tool at the position indicated by an arrow.

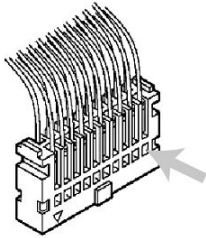

2. Hold the housing with fingers and pull the wire.

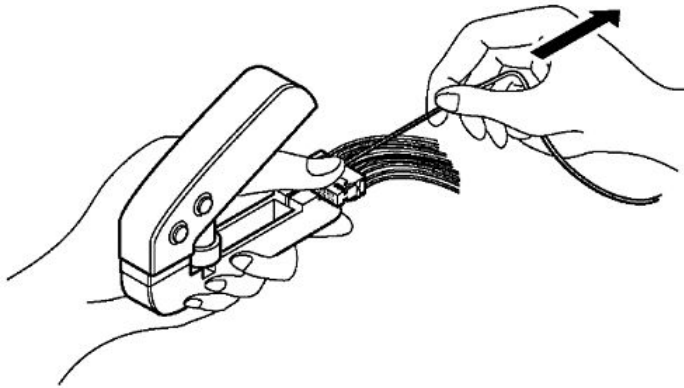

### 5.9 Safety Measures

#### 5.9.1 Safety Measures

##### ■ Precautions regarding system design

- In certain applications, malfunction may occur for the following reasons:
  - Power on timing differences between the PLC system and input/output or mechanical power apparatus.
  - Response time lag when a momentary power drop occurs.
  - Abnormality in the PLC unit, external power supply, or other devices.

In order to prevent a malfunction resulting in system shutdown, choose the adequate safety measures.

##### ■ Providing an interlock circuit

- When a motor clockwise/counter-clockwise operation is controlled, provide an interlock circuit externally.

##### ■ Providing an emergency stop circuit

- Provide a circuit to the PLC externally, which turns off the power supply of the output device in case of emergency.

##### ■ Power supply sequence

- The PLC should be started after booting the I/O device and mechanical power apparatus.
- When turning off the PLC, stop the operation of the PLC first, and then turn off the I/O devices and power equipment.

##### ■ Grounding

- When installing the PLC next to devices that generate high voltages from switching, such as inverters, do not ground them together. Use an exclusive ground with a resistance of less than 100 for each device.

#### 5.9.2 Instantaneous Power Failure

##### ■ Operation of instantaneous power failure

- If the duration of the power failure of the power supply is less than 10 ms, the FP0H Control Unit continues to operate. If it is 10 ms or longer, the operation varies according to conditions such as the combination of units and the power supply voltage. In some cases, the unit performs the same operation as resetting the power supply.

#### 5.9.3 Watchdog Timer

- The watchdog timer is a program error and hardware error detection timer.



- When the watchdog timer is activated, the "Alarm" LED on the front of the Controller is lit. When this occurs, all outputs to the output units are turned OFF and the unit is put in halted state.

(MEMO)

# 6 Procedures Before Starting Operation

---

6.1 Before Turning On the Power .....	6-2
6.1.1 Check Items .....	6-2
6.1.2 Procedures Before Starting Operation .....	6-2
6.2 Offline Editing of Project .....	6-4
6.2.1 Elements of Project .....	6-4
6.2.2 System Register Settings .....	6-4
6.2.3 Setting of Positioning Parameters .....	6-6
6.3 Project Download and Operation .....	6-7
6.3.1 Before Turning On the Power .....	6-7
6.3.2 Project Download and Mode Switching .....	6-8
6.3.3 Procedure for downloading .....	6-8
6.3.4 If "MEWNET device open error" occurs .....	6-9
6.3.5 Totally Checking Project .....	6-10
6.3.6 Verifying Project .....	6-11
6.4 Online Edit .....	6-14
6.4.1 Overview of Online Edit .....	6-14
6.4.2 Online Edit of Program .....	6-14
6.4.3 Procedure of rewriting blocks .....	6-15
6.4.4 Online Edit of System Register .....	6-16
6.5 Program Block .....	6-17
6.5.1 Overview of Program Block .....	6-17
6.5.2 Changing the Execution Order of Program Blocks .....	6-17

## 6.1 Before Turning On the Power

### 6.1 Before Turning On the Power

#### 6.1.1 Check Items

After the wiring, check the following items before turning on the power supply.

##### ■ Check items

	Item	Description
1	Installation of each unit	Whether the unit type matches the device list during the design stage or not. Whether the unit mounting screws are properly tightened or not; and whether there is any looseness or not.
2	Wiring	Whether the terminal screws are properly tightened or not; and whether there is any looseness or not. Whether the wiring of terminal matches the signal name or not. Whether the wiring has sufficient thickness for expected current or not.
3	Connecting cables	Whether the cables are securely connected or not.
4	Mode setting	Whether the mode switch is set to "PROG." or not.
5	Others	Carefully check if there is any potential for an accident.

#### 6.1.2 Procedures Before Starting Operation

Procedures following installation and wiring and before starting operation are as follows.

##### 1. Turn on the power supply.

1. Before turning on the power supply, check the items referring to "6.1.1 Check Items".
2. Turn on the power supply of the control unit and check that the "PROG." LED (green) of the control unit is on.



##### 2. Input a program.

1. Create a program using the tool software.
2. Use the "Totally Check Project" of the tool software to check for syntax errors.



##### 3. Check the output wiring.

Use the forced I/O function to check the output wiring.



### 4. Check the input wiring.

Check the input wiring by using the input display LEDs or the monitoring function of the tool software.



### 5. Perform a test operation.

1. Set the mode switch to "RUN" and check that the "RUN" LED is turned on.
2. Check the sequence operation.



### 6. Perform debugging.

1. If there is an error in the operation, check the program using the monitoring function of the tool software.
2. Correct the program.



### 7. Save the program.

Save the created program.

### 6.2 Offline Editing of Project

#### 6.2.1 Elements of Project

The items below are created as project data by the following procedure.

##### ■ Project configuration

Classification	Description
Program	Arbitrary program
Comment	Max. 1 MB I/O comments, explanatory notes, interlinear comments
System register	Set the allocations for using the hold areas of the operation memory, operation mode when an error occurs, communication, high-speed counter and pulse output function.
Positioning parameters Positioning table data	For using the pulse output function in the table setting mode, set in the Configurator PMX. The set positioning parameters and positioning table data are saved as part of a program file. By exporting or importing on the Configurator PMX, only the data related to positioning can be saved as another file.
Ethernet settings	Set the parameters related to IP address, connection, communication mode and Ethernet communication. (C32ET/C32EP only)
Ethernet/IP setting	Set the parameters related to the Ethernet/IP communication. (C32ET/C32EP only)
Logging/Trace Settings	Set the parameters related to the logging/trace function. (C32ET/C32EP only)

#### 6.2.2 System Register Settings

Set system registers by the following procedure. The following procedure is explained on the condition that the FPWIN GR7 has already started.

##### Info.

- System registers are set for using various functions and change the default settings of the hold type areas. It is not necessary to set item when those functions are not used.

##### **1 2** Procedure

1. Select **Options>System register settings** from the menu bar.  
The "PLC Configuration" dialog box appears.

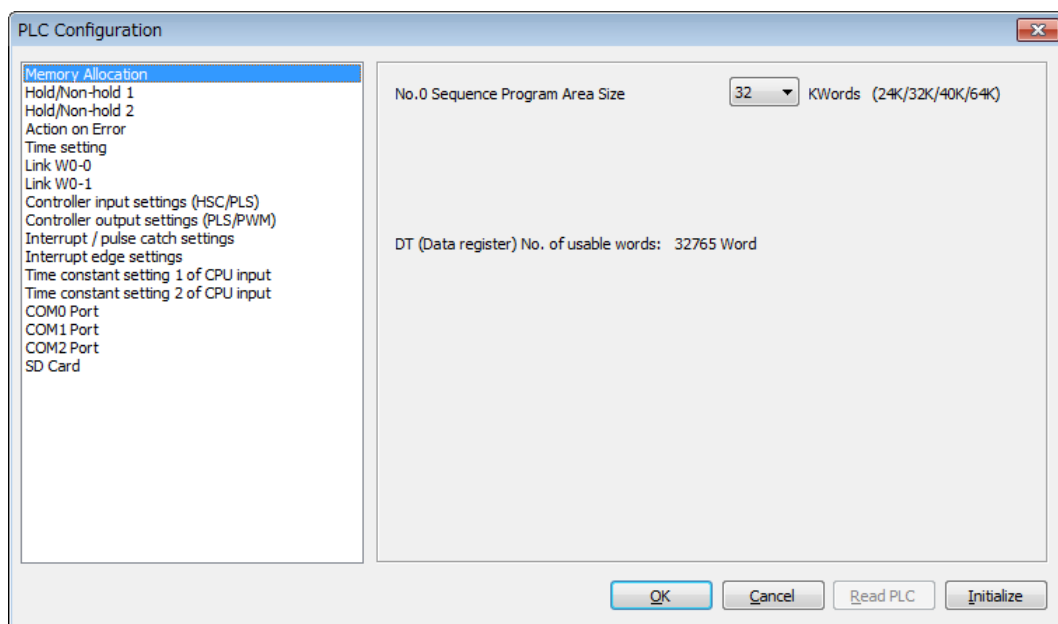

2. Select and set desired items.
3. Press the [OK] button.  
The set contents will be saved as part of the program.

### Type of system register

Classification	Description
Memory allocation	Set this item when changing the program capacity or the number of internal relay.
Hold/Non-hold	Set this item when changing the hold area of the operation memory for internal relays and data registers. For enabling this setting, a battery for memory backup (sold separately) needs to be installed.
Action on Error	The operation mode when an error such as operation error occurs can be selected. When installing the battery for memory backup, set the error annunciation function to be enabled.
Time setting	Set the timeout period when using the communication function or constant scan time.
PLC link W0 setting	Allocate the unit numbers and link areas when using the PLC link function.
Controller input and output settings (HSC/PLS/PWM)	Allocate the I/O signals and channels when using the HSC (high-speed counter), PLS (pulse output) and PWM (PWM output) functions.
Interrupt / pulse catch settings	Specify the input allocated when using the interrupt input or pulse catch input. For the interrupt input, edges to be valid can be selected.
Interrupt edge settings	
Time constant setting of CPU input	Specify the input to which the time constant filter to enable the input is applied.
COM Port	Set the communication parameters such as unit numbers, baud rate and transmission format when using the communication function via the COM port.

## 6.2 Offline Editing of Project

---

Classification	Description
SD Card	Set the SD card cover open/close detection and the allowed time of task operation when using SD cards.
Compatible mode	"FPsigma mode" or "FP0H mode" can be selected to retain compatibility with FPsigma. For details of the FPsigma mode, refer to "9.4 FPsigma Mode".

---

### REFERENCE

---

[9.4 FPsigma Mode](#)

[12.4 List of System Registers](#)

---

### 6.2.3 Setting of Positioning Parameters

When using the pulse output function in the table setting mode, set the parameters by the Configurator PMX. The Configurator PMX is started from the **Option** menu of FPWIN GR7.

#### Info.

- For the details of the pulse output function in table setting mode and the operation of Configurator PMX, refer to the *FP0H Users Manual (Positioning/PWM Output/High-speed Counter)*.



## 6.3 Project Download and Operation

### 6.3.1 Before Turning On the Power

Before turning on the power supply, check the mode selection switch of the control unit. The operation varies as follows according to the state when the power supply turns on. The mode selection switch is located under the card cover.

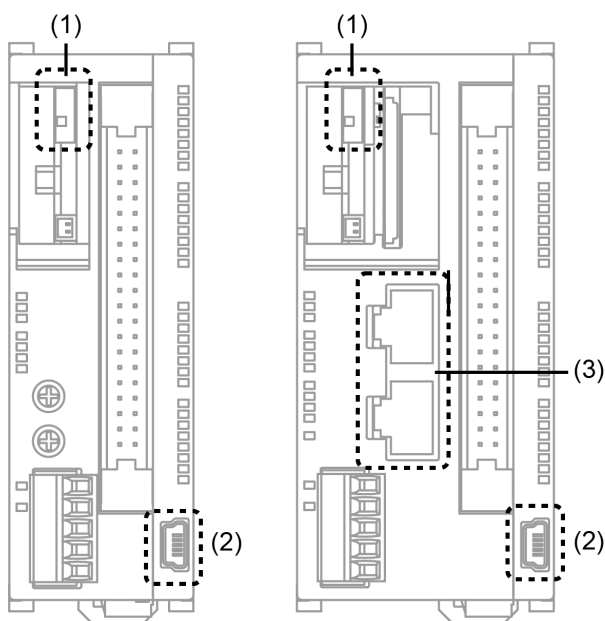

(1)	RUN/PROG. mode selection switch	Switch (Up): Sets to RUN mode. Switch (Down): Sets to Program mode.
(2)	USB port	This is used to connect with a PC on which tool software is used.
(3)	LAN port	This is used to connect with a PC on which tool software is used.

#### ■ Operational difference between the modes

Classification	Description
Power supply is turned on in PROG. mode.	When the power supply turns on, the data in the control unit and computer (programs, comments, system register data and data registers) exist. By operating the tool software, data can be downloaded from a computer to the control unit or uploaded from the control unit to a computer. When necessary data such as a program is not written in the control unit, turn on the power supply in PROG. mode.
Power supply is turned on in RUN mode.	When the power supply turns on, data saved in the internal memory (F-ROM) of the control unit is transferred to the memory of the control unit and the operation is started. When necessary data such as programs are saved and ready to be run, turn on the power supply in RUN mode.

## 6.3 Project Download and Operation

### ■ Switching the mode by the tool software

- When the power supply is on and the unit is in online state, the operation mode can be changed by the tool software. However, when the power supply is turned off and turned on again, the unit operates in the mode selected by the mode selection switch.

### ■ Connection between a computer and the control unit

- A computer is connected to the USB port of the control unit. A USB2.0 cable (A: miniB) is used for the connection.
- It can also be connected via the LAN communication port. (For details, refer to the FP0H User's Manual *Ethernet Communication*.)

### 6.3.2 Project Download and Mode Switching

- Projects created by the tool software are downloaded to the control unit.
- Downloaded projects are saved in the program memory (F-ROM) and held even in case of power outage.

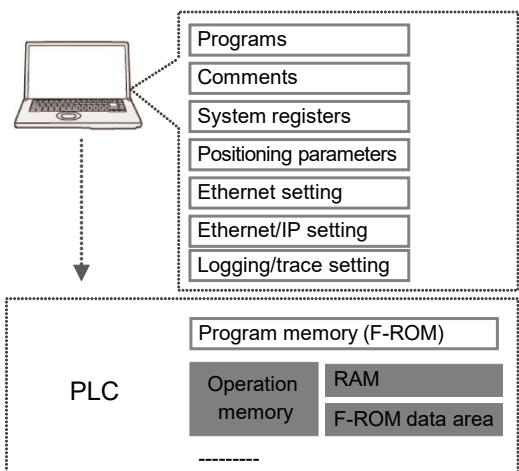

### 6.3.3 Procedure for downloading

Download project data by the following procedure. The following procedure is explained on the condition that the FPWIN GR7 has already started.

#### 1 2 Procedure

1. Select **Online>Switch to Online Mode** from the menu bar.
2. Select **Online>Download to PLC (Entire Project)** from the menu bar.  
A confirmation message dialog box appears.

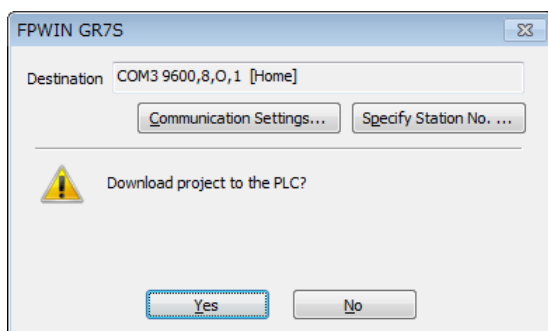

3. Press the [Yes] button.

Downloading the project is executed. A message dialog box to confirm whether to switch the mode or not appears.

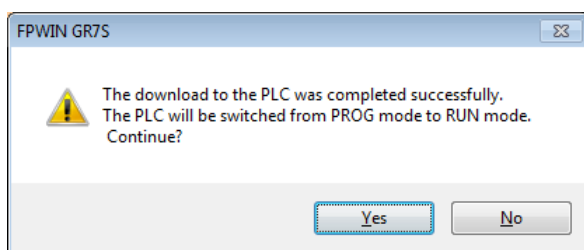

4. Press the [Yes] or [No] button.

Press [Yes] to change to the RUN mode. Press [No] to change to the monitor mode.

#### **i** Info.

- Before switching the mode to RUN mode, fully confirm that the activation of the PLC will not cause a dangerous situation.
- If an error occurs when switching the mode to RUN mode, the "ERR/ALM" LED will flash and it will return to PROG. mode.

## REFERENCE

### 10.2 What to Do If an Error Occurs

#### 6.3.4 If "MEWNET device open error" occurs

Clear the error by the following procedure.

1. Confirm that the power supply of the control unit is on.
2. Confirm that the computer and the control unit are connected with a USB cable.
3. Select **Online>Communication Settings** from the menu bar.  
The "Communication Settings" dialog box appears.

## 6.3 Project Download and Operation

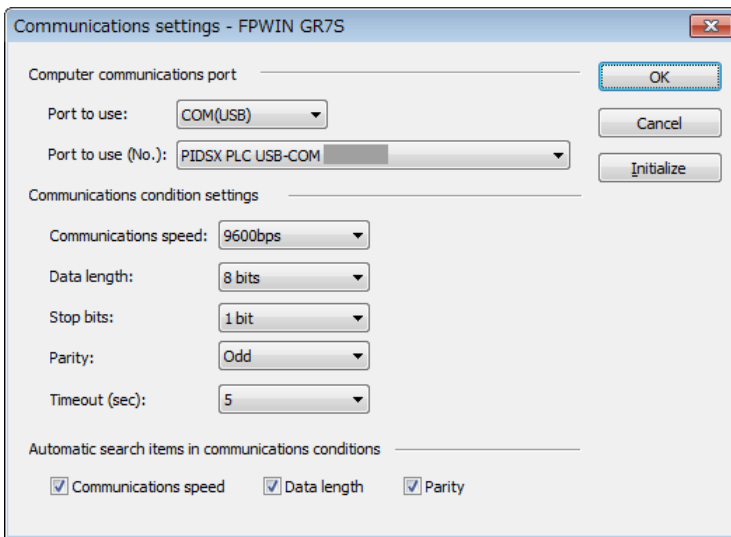

4. Confirm the port number and press the [OK] button.  
Confirm that the computer and control unit can communicate with each other.

### Info.

- The port number can be confirmed by the device manager of the computer.

### 6.3.5 Totally Checking Project

- Syntax errors can be confirmed by the total check function.
- It is possible to check if there is a duplicated use of coil or a missing in pair instructions (such as MC and MCE, JP and LBL, and SUB and RET).

#### **1 2** Procedure

1. Select **Online>Switch to Online Mode** from the menu bar.
2. Select **Debug>Totally Check Project** from the menu bar.  
The Totally Check Project dialog box appears.
3. Press the [Execute] button.  
The check result appears. If there is an error, press the [Jump] button. The window jumps to the line containing the error.

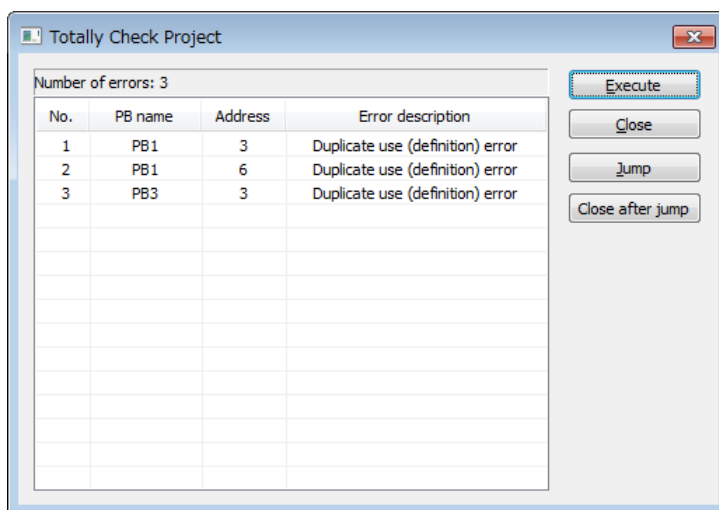

### 6.3.6 Verifying Project

Verify the project to check that the program being edited in a computer is the same as that in the control unit as necessary. The following procedure is explained on the condition that the FPCWIN GR7 has already started.

#### 1.2 Procedure

1. Select **Online>Switch to Online Mode** from the menu bar.

#### **i** Info.

- If items in a program or system register are mismatched when switching the offline mode to online mode, a message box indicating the content will appear.

2. Select **Debug>Verify Project** from the menu bar.  
The "Select Verification Targets" dialog box appears.

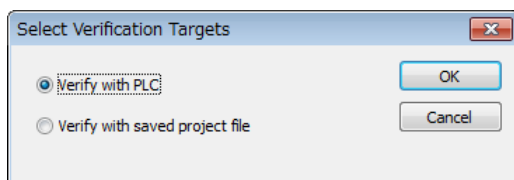

3. Select the verification target, and press the [OK] button.  
A confirmation message dialog box is displayed.  
The project currently being edited is never rewritten.

## 6.3 Project Download and Operation

---

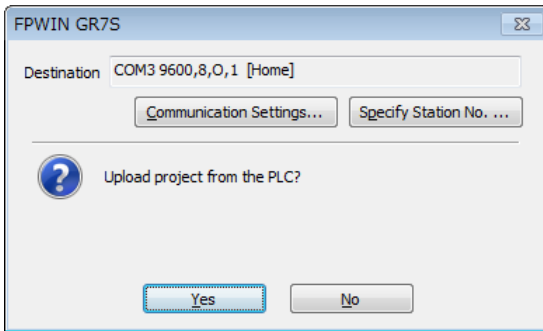

4. Press the [Yes] button.

The project is uploaded from the PLC to verify the project. The "Select Verification Items" dialog box appears.

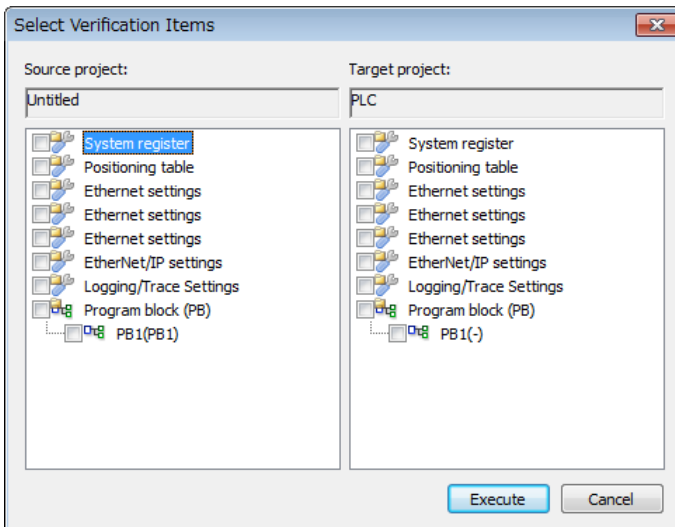

5. Select an item and press the [Execute] button.

The verification result is displayed. A mismatched item is displayed in a pink color. Double-clicking this item displays the detailed information. The following figure shows an example when System register and PB1 has been selected for the verification items.

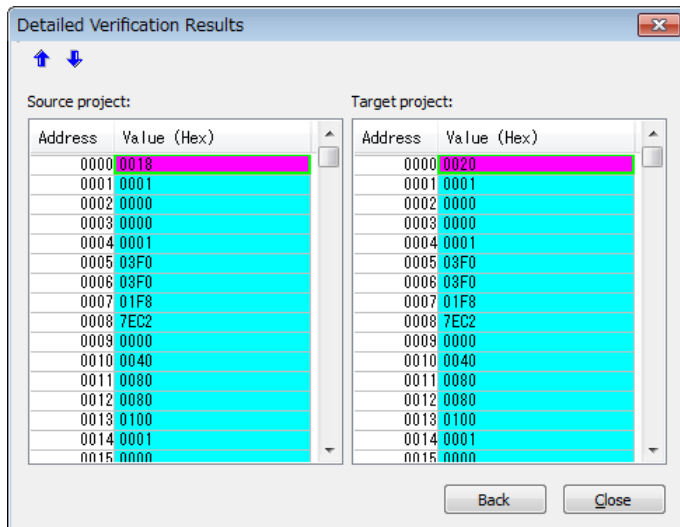
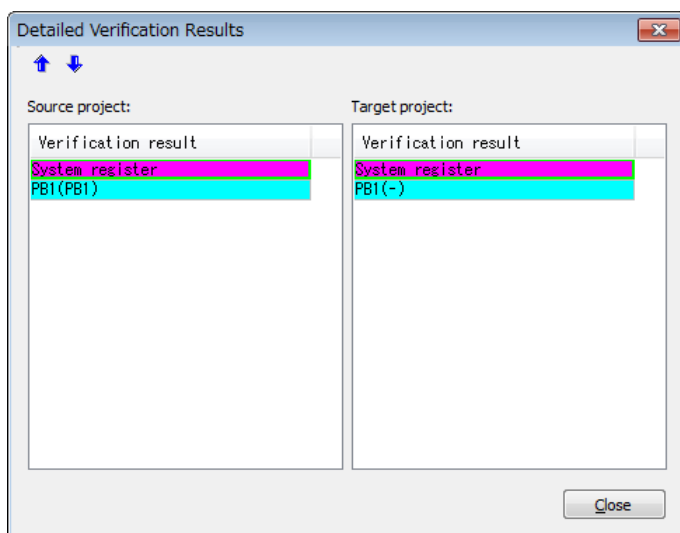

### Verification result

Verification content	Example of mismatch
System register	When the setting contents of a system register do not match, it is detected as mismatch.
Positioning table	When a positioning parameter and positioning table are different, it is detected as mismatch.
PB1	The mismatched program block number is displayed.
Ethernet settings	The mismatched items are displayed. (C32ET/C32EP only)
FTP server settings	
FTP client settings	
Ethernet/IP setting	
Logging/Trace Settings	

## 6.4 Online Edit

### 6.4 Online Edit

#### 6.4.1 Overview of Online Edit

Editing can be performed on the FP0H Control Unit under the following conditions even when a computer and PLC are connected online.

##### ■ Online edit

Classification	Mode		Point
	PROG	RUN	
Program	Available	Available	In ladder symbol mode, a maximum of 512 steps can be rewritten in each operation. As for rewriting in RUN mode, there are restrictions in the conditions to ensure consistency between programs. Whole programs can be downloaded even in RUN mode.
Comment	Available	Available	Comments can be rewritten even in RUN mode.
System register	Available	Unavailable	They can be rewritten in PROG. mode only. When attempting to perform rewriting in RUN mode, a message box to confirm the switching to PROG. mode appears.
Positioning data	Unavailable	Unavailable	It cannot be rewritten online. It should be edited offline and downloaded as a whole program.
Ethernet settings	Available	Unavailable	They can be rewritten in PROG. mode only. When attempting to perform rewriting in RUN mode, a message box to confirm the switching to PROG. mode appears. (C32ET/C32EP only)
FTP server settings			
FTP client settings			
Ethernet/IP setting			
Logging/Trace Settings	Available	Available (Note 1)	The settings can be rewritten even in RUN mode. (C32ET/C32EP only)
SSL/TLS certificate management	Available	Available	The settings can be rewritten even in RUN mode. (C32ET/C32EP only)

(Note 1) It can be edited only when the LOG number that will be edited is not operated. When attempting to edit it during the operation, "Logging error" occurs.

#### 6.4.2 Online Edit of Program

### WARNING



- Changing a program during the operation should be performed fully considering safety.



## ■ Online edit of program

The online edit of programs can be executed in PROG. or RUN mode.

### 6.4.3 Procedure of rewriting blocks

Programs can be changed in PROG. or RUN mode. The following procedure is explained on the condition that the online edit is performed with the FPWIN GR7.

#### 1 2 Procedure

1. Change an arbitrary program, press the <Ctrl> key and <F1> key, and execute "Convert PB".

A confirmation message dialog box appears.

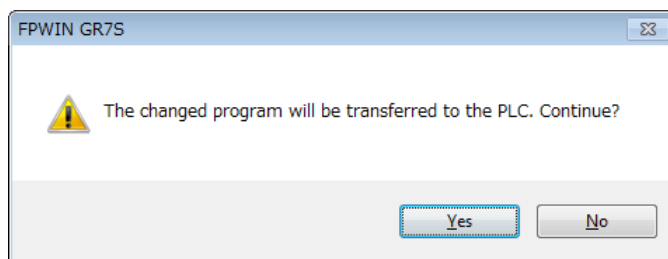

2. Press the [Yes] button.

A dialog box to confirm that the comment is changed appears.

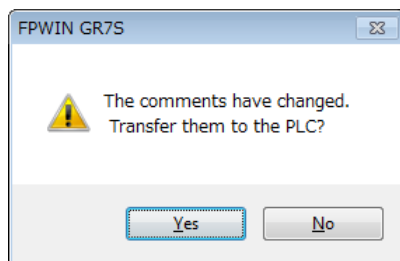

3. Press the [Yes] button.

Once the conversion is complete successfully, the status bar shows a message.

#### **i** Info.

- Interlinear comments are linked with mnemonic addresses of programs and managed within the PLC. When a program is changed online, download the program to adjust the positions of interlinear comments. Also, confirm the address position of each interlinear comment in the interlinear comment list dialog box of FPWIN GR7, and change them as necessary.

## 6.4 Online Edit

### 6.4.4 Online Edit of System Register

System registers can be changed only in PROG. mode. The following procedure is explained on the condition that the online edit is performed with the FPCWIN GR7.

#### **i** Info.

- Please change the system registers nos. 0, 1 and 3 offline. (The number 1 is only available for C32T/C32P.)

#### **1** Procedure

1. Select **Option>System register settings** from the menu bar.  
The "PLC Configuration" dialog box appears.

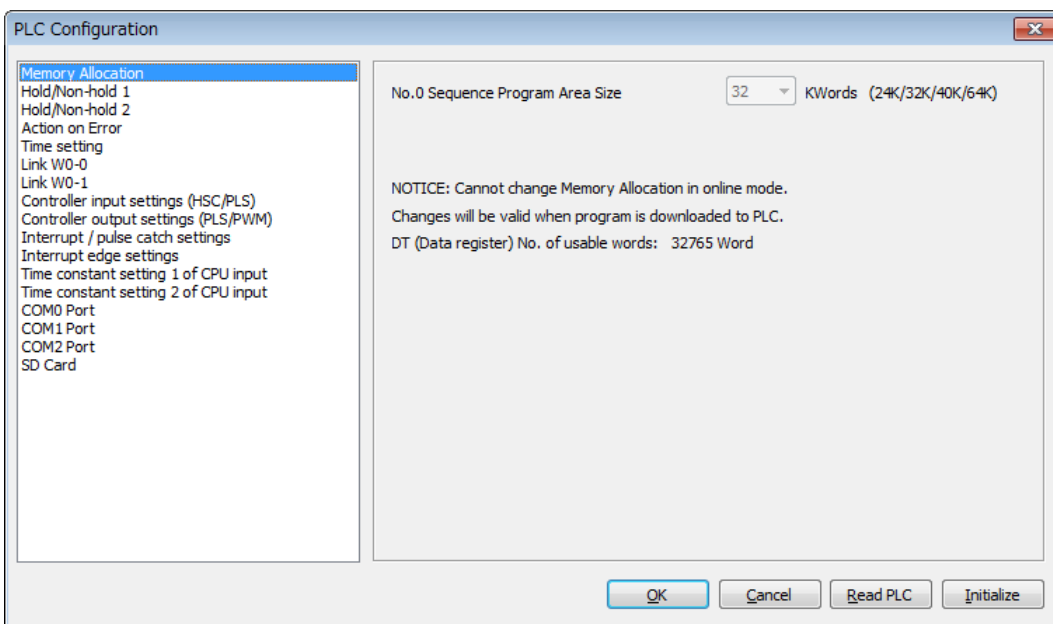

2. Change a desired system register, and press the [OK] button.  
A confirmation message dialog box appears.

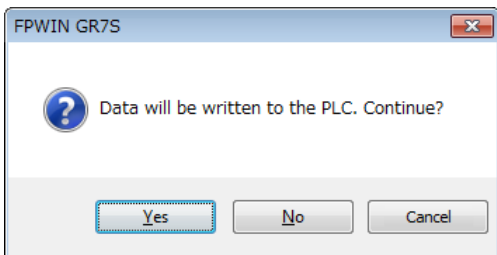

3. Press the [Yes] button.  
A message indicating the completion of writing the system register into the PLC appears.

## 6.5 Program Block

### 6.5.1 Overview of Program Block

By using the FPWIN GR7, a program can be divided into multiple program blocks (PB) and edited.

#### ■ Restrictions in program blocks (For FP0H)

Item	Description
Maximum number of PBs	Max. 256 pcs
No. of program steps per PB	No restriction

#### ■ Execution order of program blocks

- Program blocks are connected and executed as one program.
- Only one ED instruction is described at the end of a main program. Programs up to the ED instruction are executed cyclically.
- Arrange sub programs (interrupt programs, subroutines) after the ED instruction. When the order is not correct, "Not paired error" or "Program area error" occurs.

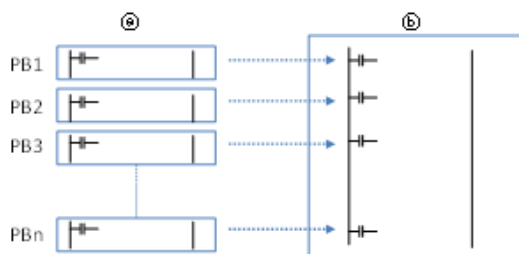

(a)	Program block	(b)	Program comprised of program blocks
-----	---------------	-----	-------------------------------------

### 6.5.2 Changing the Execution Order of Program Blocks

The execution order of program blocks can be arbitrarily changed after creating the program blocks. The following procedure describes the case when three program blocks have been already created.

#### 1 2 Procedure

1. Double-click "Change execution order" in the project tree.

## 6.5 Program Block

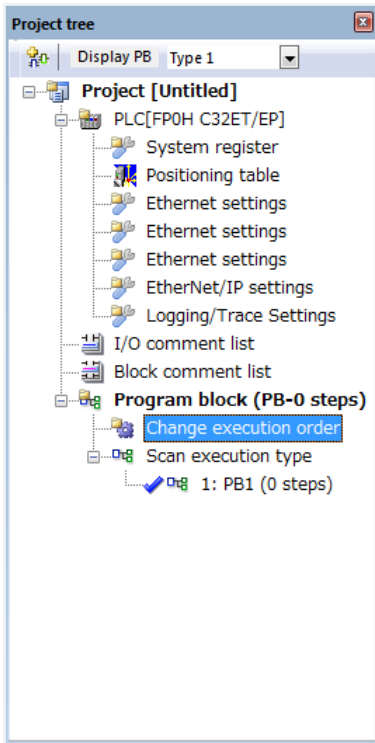

The "Change the Program Block (PB) Execution Order" dialog box appears.

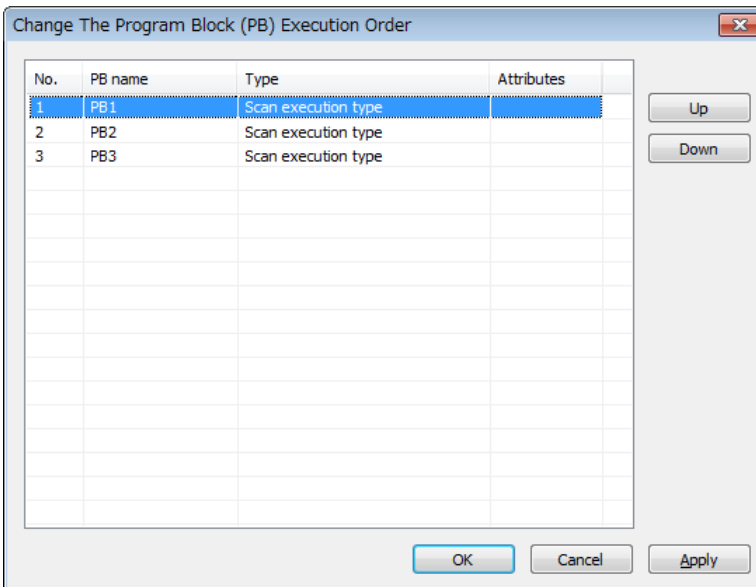

2. Select the PB you want to change the execution order, and press the [Up] or [Down] button.
3. Press the [Yes] button.  
The project tree shows the PB names in the changed order.

# 7 Memory Backup

---

7.1 Memory Backup .....	7-2
7.1.1 Backup of Program Memory .....	7-2
7.1.2 Backup of Operation Memory .....	7-2
7.1.3 Backup of Operation Memory (With Battery) .....	7-4
7.1.4 Settings of Battery Error Alarm and Hold Area .....	7-5
7.2 RAM / ROM Transfer Function .....	7-7
7.2.1 Overview of Functions .....	7-7
7.2.2 Operation Using Tool Software .....	7-7
7.3 Transfer Using SD Memory Card (C32ET/C32EP).....	7-8
7.3.1 Transfer using SD Memory Card: Overview of Functions.....	7-8
7.3.2 Operation Using Tool Software .....	7-8

## 7.1 Memory Backup

### 7.1 Memory Backup

#### 7.1.1 Backup of Program Memory

The contents downloaded to the control unit are held even in case of power outage.

##### ■ Backup of program memory

Classification	Description
Program	-
Comment	Max. 1 MB I/O comments, explanatory notes, interlinear comments
System register	-
Positioning data	Including positioning parameters and positioning table data set by the Configurator PMX
Ethernet settings	C32ET/C32EP only
Ethernet/IP setting	C32ET/C32EP only
Logging/Trace Settings	C32ET/C32EP only

#### 7.1.2 Backup of Operation Memory

- There are an area which holds data and an area which does not hold data in case of power outage in the operation memory.
- For the FP0H Control Unit, the fixed areas will be backed up in case of power outage or switching the mode (RUN to PROG.).

##### ■ Non-hold area and hold area

Classification	Description
Non-hold area	Data contents will be reset to zero in case of power outage or switching the mode (RUN to PROG.).
Hold area	The last operation data will be held in case of power outage or switching the mode (RUN to PROG.).

##### ■ Automatic backup in case of power outage

- FP0H mode

Classification	Backup method	Hold area	
Counter	Automatic backup when power is cut off	C1008 to C1023	
Counter elapsed value area		EV1008 to EV1023 <sup>(Note 1)</sup>	
Internal relay		C32T C32P	R5040 to R511F or R2480 to R255F <sup>(Note 2)</sup>
		C32ET C32EP	R5040-R511F

Classification	Backup method	Hold area
Data register <sup>(Note 3)</sup>		C32T C32P  DT32450 to DT32764 For program capacity of 32K steps DT65218 to DT65532 For program capacity of 24K steps
		C32ET C32EP  DT11970 to DT12284 For program capacity of 64K steps DT24258 to DT24572 For program capacity of 40K steps DT32450 to DT32764 For program capacity of 32K DT65218 to DT65532 For program capacity of 24K steps

(Note 1) The counter target value area SV is not held.

(Note 2) The range of the internal relays varies according to the setting of the internal relay capacity (system register no. 1).

(Note 3) The range of the data registers varies according to the setting of the program capacity (system register no. 0).

- FPsigma mode

Classification	Backup method	Hold area
Counter	Automatic backup when power is cut off	C1008 to C1023
Counter elapsed value area		EV1008 to EV1023 <sup>(Note 1)</sup>
Internal relay		R2480 to R255F (Fixed)
Data register		DT32710 to DT32764 (Fixed)

(Note 1) The counter target value area SV is not held.

### Backup by user program P13 (ICWT) instruction

Classification	Description
Usage method	Data registers can be transferred to the F-ROM area by describing the P13 (ICWT) instruction using a user program. The area of continuous blocks is specified. 2 K words are treated as one block. It is read from the F-ROM area to the data register by the F12 (ICRD) instruction.
No. of times of writing	Up to 10000 times

#### Info.

- For details of the FPsigma mode, refer to "9.4 FPsigma Mode".

## REFERENCE

### 9.4 FPsigma Mode

## 7.1 Memory Backup

### 7.1.3 Backup of Operation Memory (With Battery)

- Install an optional backup battery when the hold area is insufficient in the initial state or for using the clock/calender function.
- When the battery is installed, all of the following areas will be backed up in case of power outage or switching the mode (RUN to PROG.).

#### ■ Backup with backup battery

Classification		Hold area	
Operation memory	Timer and counter	Hold areas or non-hold areas can be specified arbitrarily by setting the system registers no.6 to no.13 using the tool software. (All points can be also held.)	
	Timer and counter elapsed value area		
	Internal relay		
	Data register		
	Step ladder		
	Link relay		
	Link register		
Special data register	Clock/calender	Monitor area	DT90053: Hour/Min. (reading only)
		Setting, monitor area	DT90054: Minute /Second, DT90055: Day/Hour, DT90056: Year/Month, DT90047: Day of week
	Logging/trace information	DT90640 to DT90643: No. of written records of current file DT90660 to DT90633: No of files (generations) stored in folder DT90680 to DT0687: Oldest clock data of file stored in folder. The clock data is the number of seconds accumulated from 00:00:00 on January 1, 2001.	

(Note 1) When battery exhaustion is detected when the power turns on, the operation memory in the hold area will be cleared to zero.

#### ■ Type of backup battery (sold separately)

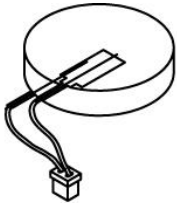
Appearance	Item name	Specifications	Product no.
	Backup battery	With a connector	AFPX-BATT

#### ■ Number of installed batteries

For the FP0H, only one battery is installed.

#### Info.

- For the details of how to install the battery, refer to "[5.2 Installation of Backup Battery](#)".



---

**REFERENCE**



---

**5.2 Installation of Backup Battery**

---

**7.1.4 Settings of Battery Error Alarm and Hold Area**
**■ Setting of the battery error alarm**

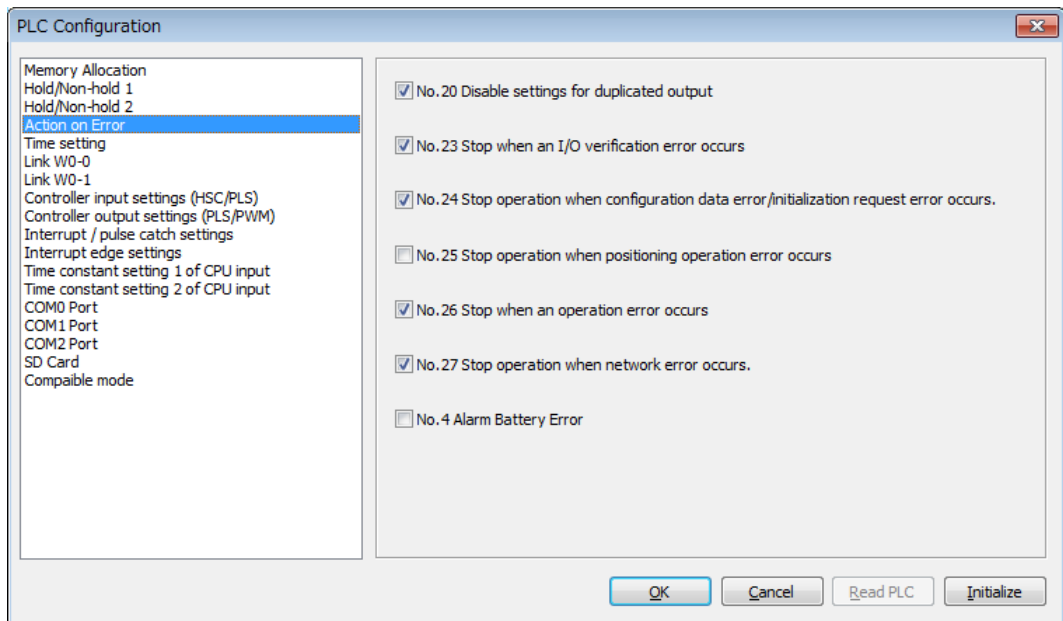
- When installing the backup battery, check the box of system register [No. 4 Alarm Battery Error].
- When a residual capacity of a battery is reduced, the "ERR/ALM" LED of the control unit will flash and the error will be notified.

**■ Settings of Hold area/Non-hold area**

To change the range of the hold area in the operation memory such as data registers, set the system registers no. 6 to no. 14.

## 7.1 Memory Backup

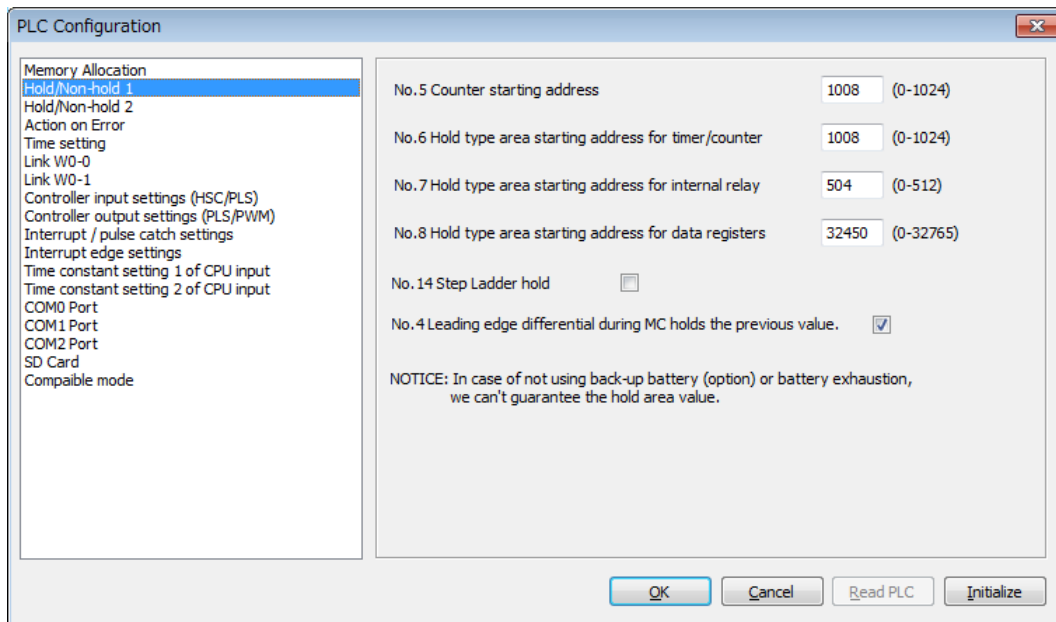

### **i** Info.

- When "Battery Error Alarm" is not set, the "ERR/ALM" LED will not flash even if a battery error is detected.
- The setting of the system registers Nos. 6 to 14 are effective only when the backup battery is installed. Without the battery, use at the default settings.

## 7.2 RAM / ROM Transfer Function

### 7.2.1 Overview of Functions

This is a function to back up the data of all areas of data registers into the internal F-ROM area of the control unit by the tool software.

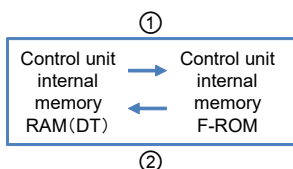

### 7.2.2 Operation Using Tool Software

The following procedure is explained on the condition that the FPWIN GR7 has already started.

#### **i** Info.

- This operation can be executed only in PROG. mode.
- Data in all areas of data registers are transferred. The specifications are different from those of conventional models FP0R, FPsigma and FP-X.

#### **1 2** Procedure

1. Select **Online>Switch to Online Mode** from the menu bar.
2. Select **Tools>ROM <=> RAM** from the menu bar.  
The "ROM <=> RAM Transfer" dialog box appears.

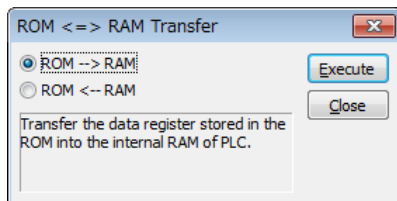

3. Select the transfer direction and click the [Execute] button.  
For ROM->RAM transfer, transfer from the F-ROM area to the data register area.  
For RAM->ROM transfer, transfer from the data register area to the F-ROM area.

## 7.3 Transfer Using SD Memory Card (C32ET/C32EP)

### 7.3 Transfer Using SD Memory Card (C32ET/C32EP)

#### 7.3.1 Transfer using SD Memory Card: Overview of Functions

This is a function to copy an execution file saved in an SD memory card on a computer into the FP0H Control Unit. This function is available for the type with Ethernet function.

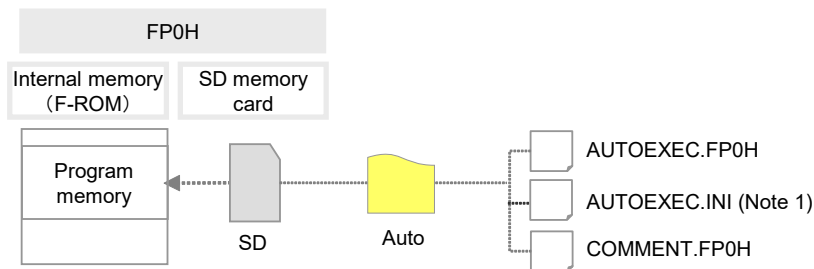

(Note 1) Transfer using an SD memory card is possible even without the "AUTOEXEC.INI" file. (Ver. 1.30 supported)

#### 7.3.2 Operation Using Tool Software

This section describes the following operations: "creating an auto running file", "creating an option setting file", "copying an auto-run file to the control unit", and "automatic transfer function of an auto-run file".

#### Creating an auto running file / an option setting file

The following procedure is explained on the condition that the FPWIN GR7 has already started.

#### 1 2 Procedure

1. Select **Tools>SD Memory Card>Create Auto-Run File** in the menu bar. The "Create auto-run file" dialog box appears.

## 7.3 Transfer Using SD Memory Card (C32ET/C32EP)

2. Select the [Refer] button and select the SD storage folder of auto-run file.
3. Select options as necessary.  
For option items, refer to the following table.

### Options for saving auto-run file

Item	Description
Set password	For setting a password for the auto-run file, check the checkbox. Enter a password between 8 and 32 characters inclusive that consists of at least one uppercase letter, at least one lowercase letter, and at least one numeric character. Symbols can be used.
Specify a limited distribution	When a password has been set for a project file saved in the control unit, the auto-run file saved in an SD memory card can be copied to the control unit only when its password coincides with the password set for the project.
Set that PLC cannot be uploaded	The file will be saved as an auto-run file that cannot be uploaded to a computer from the control unit.
Option Automatic Transfer type	Select automatic transfer type from "No automatic transfer", "When power turns on", or "When mode changes from PROG. to RUN mode".
Output only option setting file	Outputs only the option setting file.

4. Press the [OK] button.  
An auto-run file "AUTOEXEC.FP0H", a comment file "COMMENT.FP0H" and an option setting file "AUTOEXEC.INI" will be created.
5. Insert an SD memory card into a computer.
6. Create an "AUTO" folder in the SD memory card.
7. "Step 4" Copy the file created in <<Xref TAG>> into the "AUTO" folder in the SD memory card.
8. Remove the SD memory card from the computer.

## 7.3 Transfer Using SD Memory Card (C32ET/C32EP)

---

### Copying the auto-run file to the FP0H Control Unit

---

The following procedure is explained on the condition that the FPWIN GR7 has already started.

#### 1 2 Procedure

1. Insert the SD memory card into the SD card slot of the FP0H.
2. Confirm that the FP0H Control Unit is in PROG. mode.
3. Select **Tools>SD Memory Card>Copy Auto-Run File** in the menu bar.  
The confirmation dialog box appears.

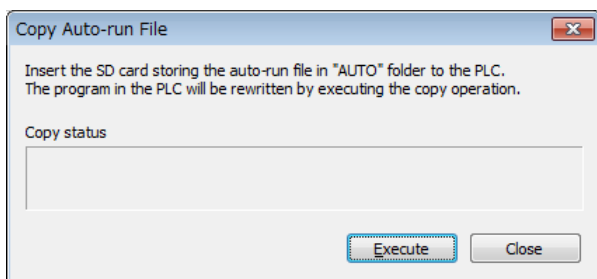

4. Press the [Execute] button.  
The auto-run file will be transferred to the internal F-ROM area of the FP0H Control Unit from the SD memory card.

#### **i** Info.

- These operations can be executed only in PROG. mode.
- The auto-run file can also be copied to the FP0H Control Unit by entering "1" in the special data register No. DT90012.

### Automatic transfer function of the auto-run file

---

Once you create an auto-run file and an option setting file in a SD memory card, you can copy the data to the FP0H Control Unit without using a PC.

Operation is different depending on whether there is an "AUTOEXEC.INI" file as a setting file in the "AUTO" folder or not. The "AUTOEXEC.INI" file can be created using a tool software.

If the automatic transfer type is set to "When switching PROG. to RUN mode", once the project copy is completed, project copy will not be performed even if you change the mode from PROG to RUN.

You can execute the project copy again only in the following cases.

- If you remove the SD memory card and insert it again
- If there is a change in the time stamp by updating the "AUTOEXEC.INI" file

## 7.3 Transfer Using SD Memory Card (C32ET/C32EP)

---

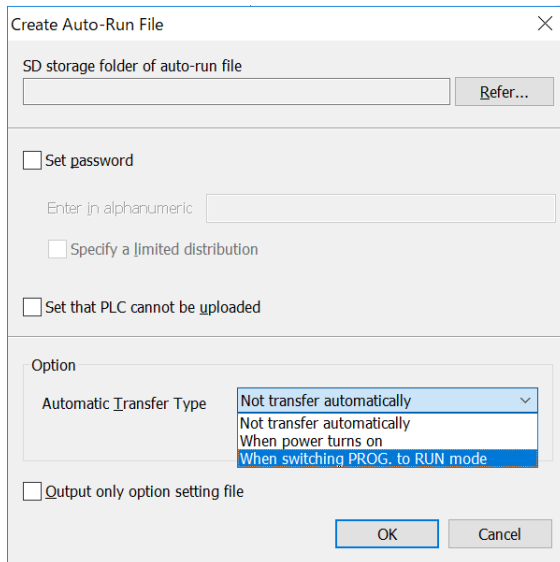

- Data transfer using the SD memory card with FPWIN GR7 is not included in the automatic transfer function using the SD memory card.

If the automatic transfer type is set to "When switching PROG. to RUN mode", after data transfer is performed with the tool using the SD memory card, change from PROG. to RUN mode, and automatic transfer using the SD memory card will be performed.

(MEMO)



# 8 Security Function

---

8.1 Password Protect Function .....	8-2
8.1.1 Overview of Functions .....	8-2
8.1.2 Setting using FPWIN GR7 .....	8-2
8.1.3 Set PLC Password dialog box .....	8-3
8.1.4 Setting to prohibit access with a password .....	8-4
8.1.5 Setting to allow access with a password .....	8-5
8.1.6 Canceling the password protection .....	8-6
8.1.7 Unprotect .....	8-6
8.1.8 Force cancel .....	8-7
8.2 Program Upload Protection Function .....	8-9
8.2.1 Overview of Functions .....	8-9
8.2.2 Configuration .....	8-9
8.2.3 Force cancel .....	8-10
8.3 Availability of Security Function .....	8-11
8.3.1 Control Unit .....	8-11

## 8.1 Password Protect Function

### 8.1 Password Protect Function

#### 8.1.1 Overview of Functions

##### ■ Overview of Password Protect Function

This function is used to prohibit reading and writing programs and system registers by setting a password. There are two ways to set a password as below.

1. Set using the programming tool.
2. Set using an instruction (SYS1 instruction). However, when using the instruction, only a password within 4 digits or 8 digits can be set. It is set using four digits or eight digits out of 32 digits from the left.

##### ■ Password input restrictions

Digit number of password	Usable characters
32-digit password	<p>For passwords, 8 to 32 one-byte alphanumeric characters (case-sensitive) and symbols can be used.</p> <p>A password must include at least one uppercase letter, at least one lowercase letter, and at least one numeric character.</p> <p>&lt;Example of valid password&gt; ABcd1234</p> <p>&lt;Examples of invalid password&gt;</p> <p>Less than 8 characters: Abc-123</p> <p>No lowercase letter included: ABCD-1234</p> <p>No uppercase letter included: abcd-1234</p> <p>No numeric character included: ABCD-efgh</p>



- Do not forget your password. If you forget your password, you cannot read programs. Even if you ask us for your password, we cannot crack it.

#### 8.1.2 Setting using FPWIN GR7

12

##### Procedure

1. Select **Online (L)> Switch to Online Mode (N)** from the menu bar, or press <CTRL> + <F2> keys simultaneously.  
The screen switches to "Online Monitor".
2. Select **Tools (T)> PLC Security Settings (S)> Set PLC Password (P)** from the menu bar.  
The "Set PLC Password" dialog box appears.

### 8.1.3 Set PLC Password dialog box

#### ■ Set PLC password dialog box

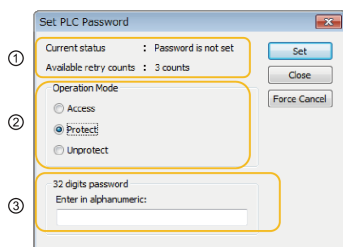

(1)	Indicates the current status of the password setting.
(2)	Specify an operation mode. Access: Accessing programs is performed by entering a password. Protect: A password is set. Unprotect: The password setting is canceled.
(3)	Input a password.

#### ■ Setting state of a password

Item		Settings
Current status	Password is not set	Password is not set.
	32 digits Protect	A password is set and access is prohibited.
	32 digits access available	A password is set and access is allowed. (The status that inputting the password completes and that can access programs.)
No. of retries	This is the number of times that you can input the password in succession. You can input up to three times, and every time incorrect password is input, the number will decrease. If you fail to input the correct password for 3 times in succession, you cannot access the program. To enter the password again, reboot the PLC by turning off and on the power. Or enter the password at a certain period of time. <a href="#">(Note 1)</a>	

(Note 1) The wait time for entering the password again varies according to the number of failures.

No. of failures	Waiting time
3	10 minutes
6	30 minutes
9	60 minutes

#### Note

- If the power supply of the PLC is turned on/off when the access is permitted, the PLC will be password protected again.

## 8.1 Password Protect Function

### 8.1.4 Setting to prohibit access with a password

#### 1 2 Procedure

1. Select **Tools>PLC Security Settings>Set PLC Password** from the menu bar. The "Set PLC Password" dialog box appears.

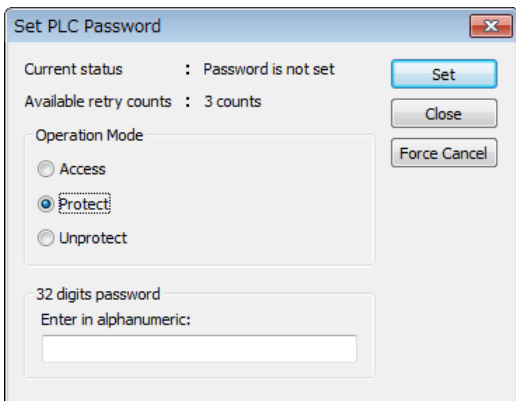

2. Set the items in the table below, and click on the [Settings] button.

Item	Settings
Operation mode	Select "Protect".
32-digit password	Input a password to be set.

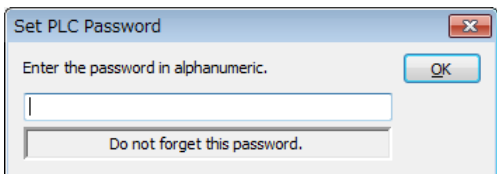

3. Input the password for confirmation again, and click the [OK] button. Once the PLC is in write-read inhibit state (password-protected), the following message appears.

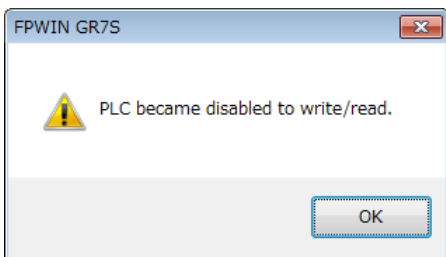

4. Click the [OK] button.

**8.1.5 Setting to allow access with a password**

The following procedure is explained on the condition that password protection has already been set for the PLC.

**1 2 Procedure**

1. Select **Tools > PLC Security Settings > Set PLC Password** from the menu bar. The "Set PLC Password" dialog box is displayed.

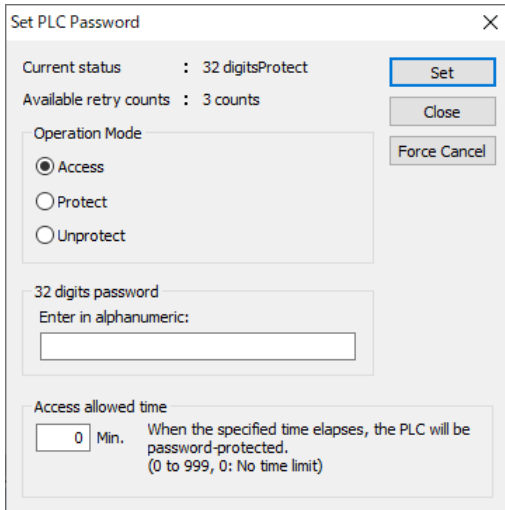

2. Set the items in the table below, and click on the [Settings] button.

Item	Settings
Operation mode	Select "Access".
32-digit password	Input the set password.
Access permission time <sup>(Note 1)</sup>	Set the time range during which access is permitted. Effective range: 0 to 999 minutes (No time limit if set to 0) The PLC returns to the password protected state after the elapse of a specified time.

(Note 1) The instruction can be used with the unit firmware Ver. 1.80 or later.

Once access is permitted, the following message appears.

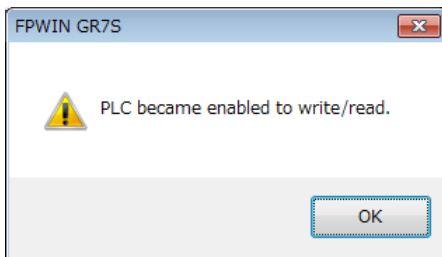

3. Click the [OK] button.

## 8.1 Password Protect Function



- If the power supply of the PLC is turned on/off when the access is permitted, the PLC will be password protected again.

### 8.1.6 Canceling the password protection

Following two methods are available to cancel the password setting.

	Description	Program
Unprotect	The registered password is specified and canceled.	All programs are retained.
Force Cancel	All programs and security information are deleted and the password is canceled.	All programs are deleted. (The upload protection setting is also deleted.)

### 8.1.7 Unprotect

#### **i** Info.

Unless the access is permitted, the cancellation of password cannot be executed.

#### **1 2** Procedure

1. Select **Tools>PLC Security Settings>Set PLC Password** from the menu bar. The "Set PLC Password" dialog box appears.

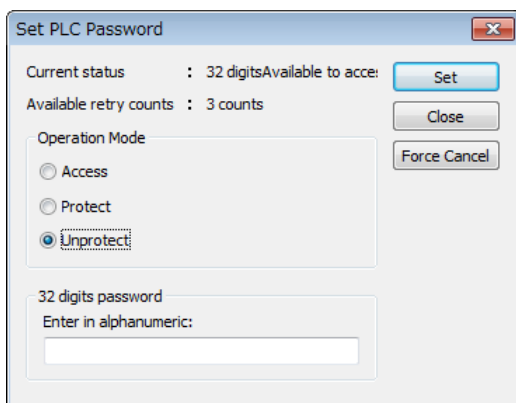

2. Set the items in the table below, and click on the [Settings] button.

Item	Settings
Operation mode	Select "Unprotect".
32-digit password	Input the set password.

Once the cancellation of protection is completed, the following message appears.

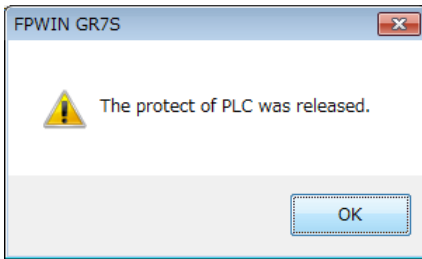

3. Click the [OK] button.

### 8.1.8 Force cancel



- Executing a force cancel will delete all programs, security information, and server certificates.

## 1 2 Procedure

1. Select **Tools>PLC Security Settings>Set PLC Password** from the menu bar. The "Set PLC Password" dialog box appears.

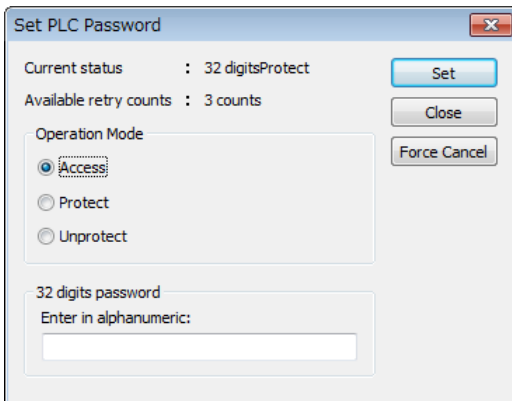

2. Click the [Force Cancel] button. A confirmation message appears.

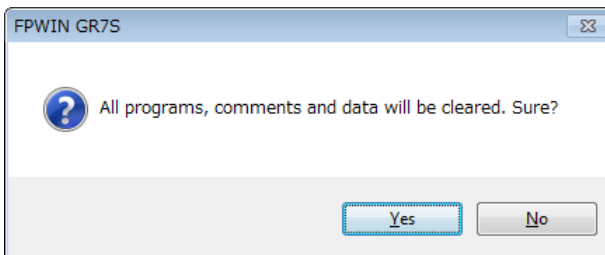

3. Confirm the message and click the [OK] button.

## 8.1 Password Protect Function

---

"Current status" shows "password is not set". All programs and security information were deleted.

Set PLC Password

Current status : 32 digits Available to access:

Available retry counts : 3 counts

Operation Mode

Access

Protect

Unprotect

32 digits password

Enter in alphanumeric:



## 8.2 Program Upload Protection Function

### 8.2.1 Overview of Functions

#### ■ Overview of program upload protection function

- This function is to prohibit reading programs and system registers by setting to disable program uploading.
- If the upload protection is set, note that the ladder programs and system registers will be disabled to be uploaded after that.
- The setting can be canceled using the programming tool, however, all ladder programs, system registers and password information will be deleted when the setting is canceled.
- Editing the files that are controlled with a PC can be carried out online using the programming tool. However, the programs will be broken if the programs are not absolutely matched. When using this function, store ladder programs as files without fail.

#### ■ Interaction with the password protect function

- The password setting can be specified simultaneously for the PLC in which this function is set.
- This function can be also set in a password-protected PLC.



- All programs and security information will be deleted when the upload protection setting is canceled. We cannot restore the deleted programs even if you ask us.

### 8.2.2 Configuration

#### 1 2 Procedure

1. Select **Online>Switch to Online Mode** from the menu bar.  
The screen switches to "Online".
2. Select **Tools>PLC Security Settings>Disable Uploading** in the menu bar.  
The "Disable Uploading" dialog box appears.

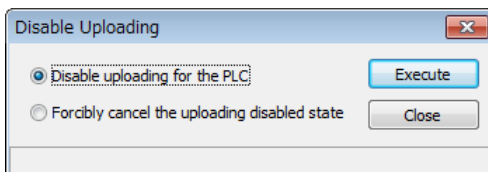

3. Select "Disable uploading for the PLC", and press the [Execute] button.

## 8.2 Program Upload Protection Function

---

### 8.2.3 Force cancel

#### **1 2** Procedure

1. Select "Forcibly cancel the uploading disabled state" in the "Upload settings" dialog box, and press the [Execute] button.

## 8.3 Availability of Security Function

### 8.3.1 Control Unit

The conditions for enabling the security operation in the control unit are as follows.

●: Available, X: Not available

Setting/Canceling Target of operation	Security function setting state		
	Security unset	Upload protection	32-digit password
Upload protection	●	●	X
32-digit password	●	X	●

(MEMO)

# 9 Other Functions

---

9.1 Clock/calender .....	9-2
9.1.1 Overview of Function .....	9-2
9.1.2 Clock/calendar Setting .....	9-2
9.1.3 Application Example of Clock/calendar.....	9-3
9.2 Potentiometer Input (C32T/C32P) .....	9-5
9.2.1 Overview of Functions .....	9-5
9.2.2 Example Showing How to Use Potentiometer Input .....	9-5
9.3 Input Time Constant Setting Function.....	9-6
9.3.1 Overview of Functions .....	9-6
9.4 FPsigma Mode.....	9-7
9.4.1 Overview of FPsigma Mode.....	9-7
9.4.2 Converting Projects for FPsigma to Projects for FP0H (FPsigma Mode).....	9-8
9.4.3 Converting Projects for FP0H (FPsigma Mode) to Projects for FP0H (FP0H Mode) .....	9-9

## 9.1 Clock/calender

### 9.1 Clock/calender

#### 9.1.1 Overview of Function

The clock data is stored in the special data register and read by user programs.

##### ■ Clock/calender function

Item	Specifications	
Clock/calender (Realtime clock)	Function	Year (Last two numbers), month, day, hour (24-hour), minute, second and day of the week Supports up to year 2099. Supports leap years.
	Accuracy	Accuracy differs according to the ambient temperature. 25°C: ± 90 seconds max. per month

(Note 1) The setting by the time acquisition from the SNTP server is only available for C32ET and C32EP.  
Refer to *FP0H User's Manual (Ethernet Communication)* for the setting method.

##### ■ Area used for the clock/calender ●: Available No mark: Not available

Special DT no.	Data contents				R	W
	High byte		Low byte			
DT90053	Hour data	H00-H23	Minute data	H00-H59	●	
DT90054	Minute data	H00-H59	Second data	H00-H59	●	●
DT90055	Day data	H01-H31	Hour data	H00-H23	●	●
DT90056	Year data	H00-H99	Month data	H01-H12	●	●
DT90057	—		Day-of-the-week data	H00-H06	●	●

(Note 1) For the data of day of week, an arbitrary day of week is specified in the range of H00 to H06.

#### 9.1.2 Clock/calendar Setting

The clock/calender can be set by the tool software, user program or time acquisition from the SNTP server.

##### ■ Setting with tool software

Select **Tools>Set PLC Date/Time** from the menu bar.

To synchronize the clock / calendar of the PLC with the PC, select the [Set PC date / time] checkbox. (FPWIN GR7 Ver. 2.22 or later)

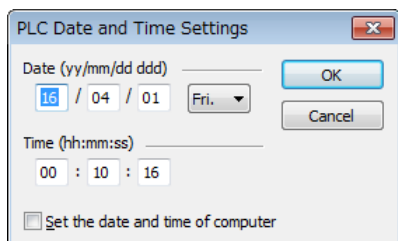

**i Info.**

- The clock/calendar data is backed up by the battery. Attach the battery before setting.

■ **Setting with user programs**

Write H8000 to DT90058 after writing the clock data in the special data registers DT90054 to DT90057. Perform the transfer with the differential instruction, or transfer H8000 through H0000 in this order. Please do not always write H8000.

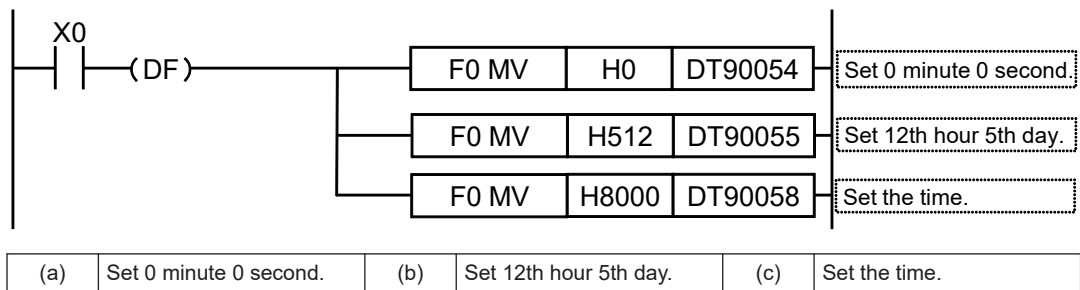

**9.1.3 Application Example of Clock/calender**

■ **Usage example (Automatic start at a fixed time)**

- In the example shown here, the clock/calendar (realtime clock) function is used to output the (Y0) signal for one second, at 8:30 a.m. every day. Here, the "Hour/minute" data stored in the special data register DT90053 is used to output the signal at the appointed time.
- The hour data is stored in the upper 8 bits of DT90053 and the minute data in the lower 8 bits, in the BCD format. This hour and minute data is compared with the appointed time (BCD), and the R900B (=flag) special internal relay is used to detect whether or not it matches the appointed time.

## 9.1 Clock/calender

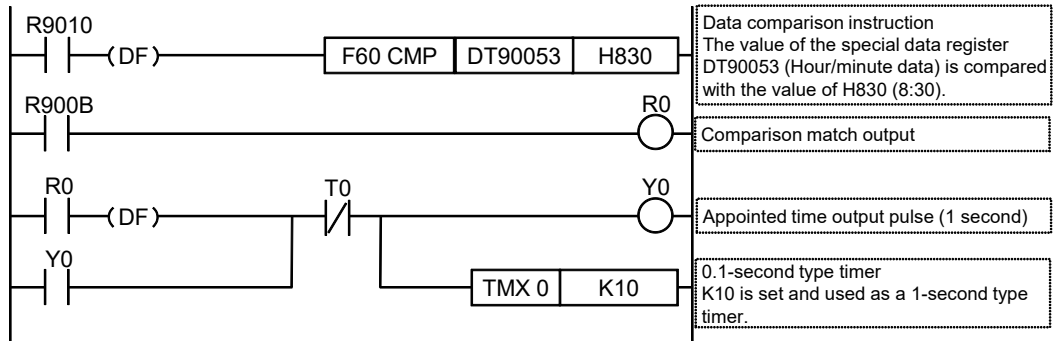

(a)	The value of the special data register DT90053 (Hour/minute data) is compared with the value of H830 (8:30).				
(b)	Comparison match output	(c)	Appointed time output pulse (1 second)	(d)	0.1-second timer: Set K10. It is used as 1-second timer.



## 9.2 Potentiometer Input (C32T/C32P)

### 9.2.1 Overview of Functions

#### ■ Overview of Functions

- The FP0H Control Unit is equipped with two potentiometers.
- Turning these potentiometers change the values of special data register DT90040/DT90041 within the range of K0 to K4000. Using this function makes it possible to change the internal set values in the PLC without using the programming tool, so this can be used, for example, with analog clocks, to change the set value by turning the potentiometer. For the FPsigma mode, the ranges of the values of V0 and V1 are both K0 to K1000.

Symbol	Special data register	Range of values	No. of bits
V0	DT90040	0 to 4000	12 bits
V1	DT90041	0 to 4000	12 bits

#### **i** Info.

- For details of the FPsigma mode, refer to "9.4 FPsigma Mode".

#### REFERENCE

[9.4 FPsigma Mode](#)

### 9.2.2 Example Showing How to Use Potentiometer Input

#### ■ Example of application to the timer

The value of the special data register (DT90040) that corresponds to potentiometer input V0 is sent to the set value area (SV0) of TMX0 to set the time for the clock.

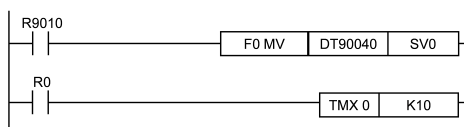

## 9.3 Input Time Constant Setting Function

### 9.3 Input Time Constant Setting Function

#### 9.3.1 Overview of Functions

##### ■ Operation when setting the input time constant processing

- The input time constant of the control unit can be set by changing the values of the system registers no. 430 to 433 using the programming tool.
- If this setting is specified, an operation like the equivalent circuit below will be performed. By the setting, the noises or chattering of input will be removed.

CXn = Input signal of Xn contact

Xn = Image memory of input Xn

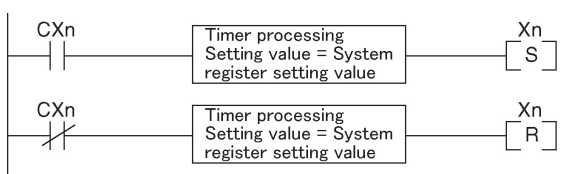

(Note 1) The timer instruction is not used for the timer processing in this equivalent circuit.

##### **i** Info.

- The input signal of X contact is retrieved at the timing of the normal I/O update.
- If the partial update instruction is executed for the input in the time constant processing, the time constant processing will be invalid, and the input status at the time will be read out and set.
- The time constant processing is invalid when the high-speed counter, pulse catch or interrupt has been specified.
- The time constant processing can also be set for inputs of other devices (expansion unit) than the control unit by using the F182 (FILTR) instruction.

##### ■ Input time constant setting function

System register No.	Control unit input I/O No.
430	X0 to X3
431	X4 to X7
432	X8 to XB
433	XC to XF

##### ■ Input time constant processing when power is turned ON

You can select whether to apply the input time constant to the input state when power is turned ON by changing the value of the system register no. 438 using the programming tool.

Available on FP0H Ver.1.9 or later

System register No.	Selection
438	<ul style="list-style-type: none"> <li>• After a time constant (default value)</li> <li>• Immediately (Input time constant setting is not applied.)</li> </ul>

## 9.4 FPsigma Mode

### 9.4.1 Overview of FPsigma Mode

FPsigma mode is a mode for using projects for the existing model FPsigma series in FP0H. Although some functions of FP0H are limited, compatibility with FPsigma is maintained.

#### ■ Comparison of specifications

Item		Specifications		
		Conventional model FPsigma series	FP0H series	
			FPsigma mode	FP0H mode Values in [ ] are for C32E only.
Program capacity <sup>(Note 1)</sup>		32K steps	24K / 32K steps	24K / 32K / [40K / 64K] steps
Data register capacity <sup>(Note 1)</sup>		32765 words	65533 / 32765 words	65533 / 32765 / [24573 / 12285] words
Automatic backup in case of power outage <sup>(Note 2)</sup>	Internal relay	R2480 to R255F (Fixed)	R2480 to R255F (Fixed)	R5040 to R511F [R2480 to R255F]
	Data register	DT32710 to DT32764 (Fixed)	DT32710 to DT32764 (Fixed)	[DT11970 to DT12284 DT24258 to DT24572] DT32450 to DT32764 DT65218 to DT65532
Pulse/PWM output setting (System register no. 402)		No setting	Cannot be set.	Can be set.
Positioning control mode (System register no. 407)		Cannot be set.	FPsigma compatible instruction mode (Fixed)	Select from table setting mode or FPsigma compatible instruction mode.
Value when system registers are initialized	No.7	248 (Fixed)	248 (Fixed)	[C32] Initialize according to system register no. 1. [C32E] 504 (Fixed)
	No.8	32710 (Fixed)	32710 (Fixed)	Initialize according to system register no. 0.
	No.407	Cannot be set.	FPsigma compatible instruction mode	Table setting mode
	No.430 to No.433	Cannot be set.	No setting	1 ms

(Note 1) The program capacity and data register capacity can be changed according to the setting of system register no. 0.

(Note 2) In the FP0H mode, the automatic backup areas for internal relays and data registers vary according to the settings of system register nos. 0 and 1.

## 9.4 FPsigma Mode

Item	Specifications		
	Conventional model FPsigma series	FP0H series	
		FPsigma mode	FP0H mode Values in [ ] are for C32E only.
Potentiometer input (DT90040/90041)	K0 to K1000	K0 to K1000 (C32 only)	K0 to K4000 (C32 only)
High-speed counter/Pulse output <sup>(Note 1)</sup>	4 ch / 2 ch High-speed counter and pulse output share the same memory area	4 ch / 2 ch High-speed counter and pulse output share the same memory area	4 ch / 4 ch High-speed counter and pulse output use independent memory areas

(Note 1) for the details of the high-speed counter/pulse output functions, refer to *FP0H User's Manual (Positioning/PWM Output/High-speed Counter)*.

### 9.4.2 Converting Projects for FPsigma to Projects for FP0H (FPsigma Mode)

Projects for the conventional model FPsigma can be converted to projects for FP0H (FPsigma mode) by the "Convert PLC Type" function. The following procedure is explained on the condition that a project for FPsigma has been already started on FPWIN GR7.

#### 1 2 Procedure

1. Select **Tools>Convert PLC Type** in the menu bar.
2. Select "FP0H" from the list on the left.

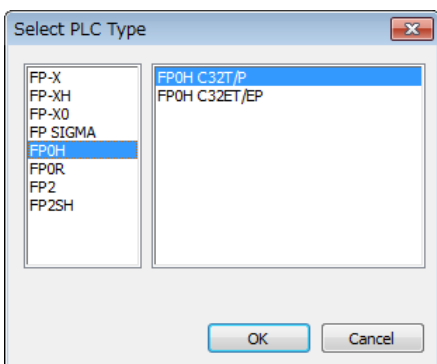

3. Select "FP0H C32T/P" or "FP0H C32ET/EP" and press the [OK] button.
4. The "Convert PLC Type" function will be executed and the project for FPsigma will be converted to the project for FP0H.

#### **i** Info.

- Whether the project file is in FP0H mode or FPsigma mode can be confirmed by using system register no. 3 "Compatible mode setting".

- For details of how to confirm this, refer to "9.4.3 Converting Projects for FP0H (FPsigma Mode) to Projects for FP0H (FP0H Mode)".

### 9.4.3 Converting Projects for FP0H (FPsigma Mode) to Projects for FP0H (FP0H Mode)

Projects for FP0H (FPsigma mode) can be converted to projects for FP0H (FP0H mode) by setting the system register number 3. The following procedure is explained on the condition that a project for FP0H (FPsigma mode) has been already started on FPWIN GR7.

#### **i** Info.

- Please change the system registers number 3 offline.

## **1 2** Procedure

1. Select **Options>System register settings** from the menu bar.
2. Select "Compatible mode" from the list on the left.

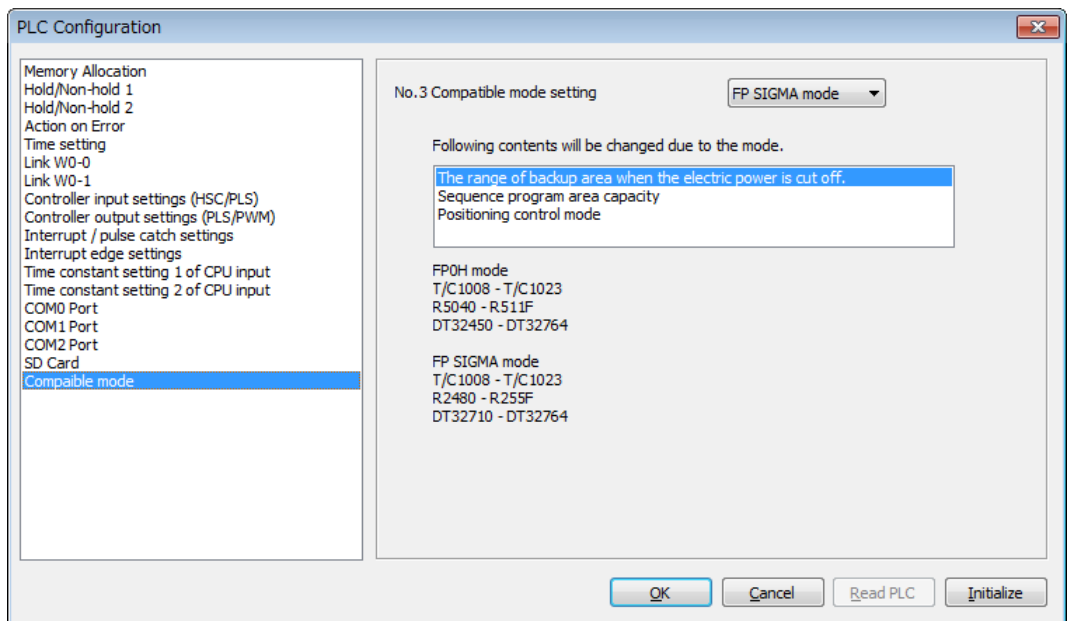

3. Change "No.3 Compatible mode setting" to "FP0H mode" and press the [OK] button.
4. Select **Online>Download to PLC (Entire Project)** from the menu bar.

(MEMO)

# 10 Troubleshooting

---

10.1 Self-diagnostic Function.....	10-2
10.1.1 Operation monitor LEDs of Control Unit .....	10-2
10.1.2 Operation Mode When an Error Occurs .....	10-2
10.2 What to Do If an Error Occurs.....	10-4
10.2.1 ERR/ALM LED Flashes .....	10-4
10.2.2 Mode does Not Change to RUN Mode .....	10-5
10.2.3 ERR/ALM LED Lights .....	10-5
10.2.4 ALL LEDs are OFF .....	10-6
10.2.5 A Protect Error Message Appears .....	10-6
10.2.6 Diagnosing Output Malfunction.....	10-7
10.2.7 Communication Error Occurs (RS-232C) .....	10-8
10.2.8 Communication Error Occurs (RS-485).....	10-9

## 10.1 Self-diagnostic Function

### 10.1 Self-diagnostic Function

#### 10.1.1 Operation monitor LEDs of Control Unit

- The control unit has a self-diagnostic function which identifies errors and stops operation if necessary.
- When an error occurs, the status of the status indicator LEDs on the control unit vary, as shown in the table above.

##### ■ LEDs related to self-diagnostic errors

	LED display			Description	Operation status
	RUN (Green)	PROG. (Green)	ERR/ALM (Red)		
In normal condition	ON	OFF	OFF	Normal operation	Operating
	OFF	ON	OFF	Program mode LED does not flash even if the forcing output is performed in program mode.	Stop
	Flashes (Note 1)	Flashes (Note 1)	OFF	Forced input / output in RUN mode	Operating
	Flashes (Note 1)	Flashes (Note 1)	OFF	Control Unit or Expansion Unit version is being updated.	Stop
Abnormal condition	ON	OFF	Flashes	Self-diagnostic error (During operation)	Operating
	OFF	ON	Flashes	Self-diagnostic error (During stop)	Stop
	OFF	ON	ON	System watchdog timer has been activated	Stop

(Note 1) Flashes "RUN" and "PROG." LED alternately.

#### 10.1.2 Operation Mode When an Error Occurs

Normally, when an error occurs, the operation stops. For some errors, the user may select whether operation is to be continued or stopped by setting the system registers.

##### ■ "PLC Configuration" dialog box of FPWIN GR7

To specify the steps to be taken by the FPWIN GR7 if a PLC error occurs, select **Option>System register settings** on the menu bar, and click on the "Action on Error" tab. The screen shown below is displayed.



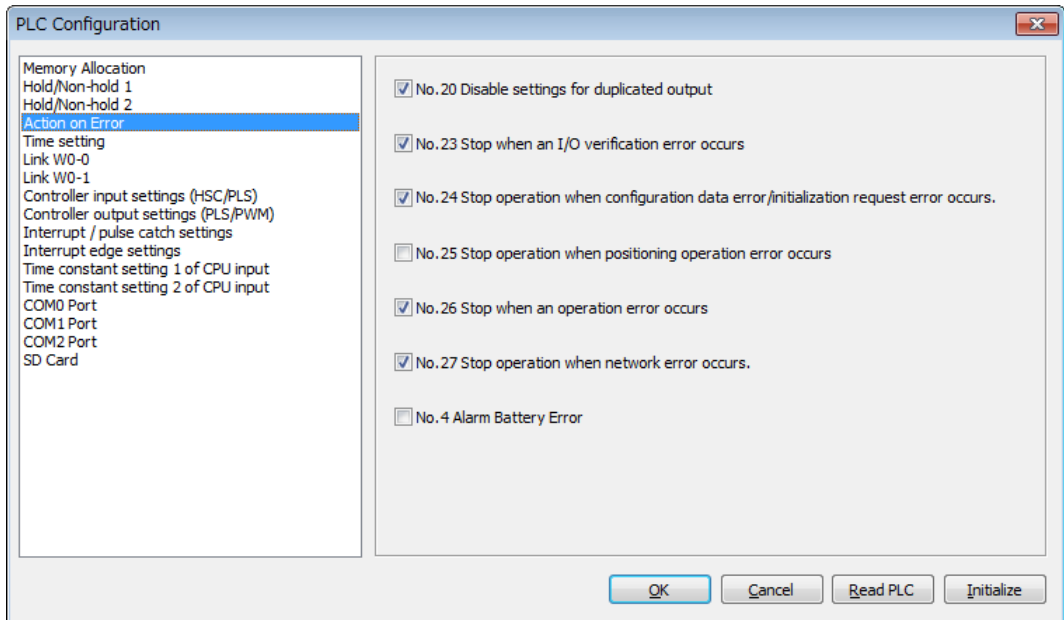

**10.2 What to Do If an Error Occurs**

**10.2.1 ERR/ALM LED Flashes**

■ **Situation**

A syntax error or self-diagnostic error has occurred.

■ **Solution**

1. Check the error code using the programming tool.

If an error occurs in the PLC during programming or debugging, display the "Status Display" dialog box and check the contents of the self-diagnosed error message.

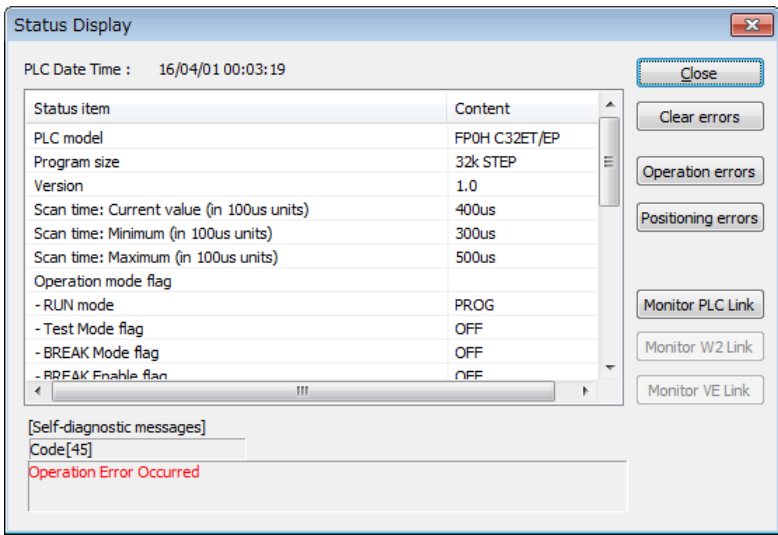

2. Confirm the error code and eliminate the cause.

**Error Codes and How to Handle Them**

Error code	Situation	Solution
1 to 9	Syntax error occurs.	<ul style="list-style-type: none"> <li>• Change to PROG. mode and clear the error.</li> <li>• Execute a total-check function using FPWIN GR7 to determine the location of the syntax error and correct the program.</li> </ul>
20 or more	Self-diagnostic error occurs.	<ul style="list-style-type: none"> <li>• Refer to the list of error codes and correct the settings or programs.</li> <li>• Use the programming tool in PROG. mode to clear the error.</li> </ul>

**i Info.**

- In the case of an error code 43 or higher, the error can be cleared by pressing the [Clear Error Log] button in the "Status Display" dialog box. An error state can also be cleared by executing self-diagnostic error set instruction F148 (ERR). In the PROG. mode, the power supply can be turned off and then on again to clear the error, but all of the contents of the operation memory except hold type data will be cleared.
- When the positioning error (error code 44) occurs, the detailed information on the error can be confirmed. Press the [Positioning errors] button to check the error code.
- When the operation error (error code 45) occurs, the address at which the error occurred is stored in special data registers DT90017 and DT90018. If this happens, click on the [Operation Errors] button in the "Status display dialog box" and confirm the address at which the error occurred before canceling the error.
- When a network error (error code 46) occurs, detail information of the error is stored in the special data register No. DT90590. Check DT90590 to find the cause of the error.
- For details of the solution when the positioning error (error code 44) occurs, refer to *FP0H User's Manual (Positioning/PWM Output/High-speed Counter Function)*.
- For details about the error codes under "Details of network errors", refer to the *FP0H User's Manual (Ethernet Communication)*.

**REFERENCE**[12.9 List of Error Codes](#)**10.2.2 Mode does Not Change to RUN Mode****■ Situation**

A syntax error or a self-diagnostic error that caused operation to stop has occurred.

**■ Solution**

1. Check if the "ERR/ALM" LED is flashing or lights.
2. Use the tool software to perform "Totally Check Project" to confirm the syntax error.

**10.2.3 ERR/ALM LED Lights****■ Situation**

The system watchdog timer has been activated and the operation of the controller has stopped.

**■ Solution**

1. Switch the mode to PROG. mode and turn on the power supply again.  
If the "ERR/ALM" LED lights again, there may be a problem with the unit. If it goes out, the problem may have been caused by noise or another temporary phenomenon.
2. Switch the mode to RUN mode.

## 10.2 What to Do If an Error Occurs

---

When the "ERR/ALM" LED turns on after switching the mode to RUN mode, the program execution time is too long. Review the program and correct it if necessary.

### **Note**

When reviewing the program, check the following items.

- Check if the program is programmed to be in an infinite loop by an instruction which controls the flow of a program such as JP instruction and LOOP instruction.
  - Check if interrupt instructions are executed in succession.
- 3.** Check the surrounding environment if there is no influence of noise.  
If there is no problem in the program, there may be a problem in the surrounding environment. Check the wirings including a ground wiring.

### 10.2.4 ALL LEDs are OFF

#### ■ **Situation**

It is possible that sufficient power is not supplied.

#### ■ **Solution**

Check the condition according to the following procedure.

- 1.** Power off the unit and double-check the wiring status. (e.g. Is there any loose terminal?)
- 2.** Check if the power supplied to the control unit is in the range of the rating.
- 3.** Check if a large voltage fluctuation does not occur.
- 4.** Disconnect the power supply wiring to the other devices if the power supplied to the control unit is shared with them.  
If the LED of the unit turns on in this processing, under capacity of power supply is possible. Review the power supply design.

### 10.2.5 A Protect Error Message Appears

#### ■ **Situation**

It is possible that the project is password locked.

#### ■ **Solution (When using the password function)**

- 1.** Select **Tools>Set PLC Password** in the FPWIN GR7.  
The "Set PLC Password" dialog box appears.
- 2.** Select "Access" and click the [Set] button.  
The protection will be canceled.

**i Info.**

- Pressing the [Force Cancel] button will delete all programs saved to the PLC.

**10.2.6 Diagnosing Output Malfunction****■ Situation**

Possible factors are those caused by software such as a program or I/O allocation and caused by hardware such as wirings or power supply.

**■ Solution (Check of output condition)**

Check the conditions in the order of the output side and input side.

1. Check if the output indicator LEDs of the units are on.  
When the LEDs are on, go to the next step. When they are off, go to step "Step 4".
2. Check the wiring state of the loads such as looseness of terminals.  
If the LED of the unit turns on in this processing, under capacity of power supply is possible. Review the power supply design.
3. Check if the voltage is properly applied to the loads.  
If the applied voltage is correct, there is probably an abnormality in the load. If the correct voltage is not applied, there is probably an abnormality in the output part of the unit.
4. Monitor the output state using the tool software.  
If the monitor state is on, there is probably a duplicated output error.
5. Forcibly turn on/off the corresponding output using the forced I/O function of the tool software.  
If the output LED of the unit turns on, check the condition on the input side. If the LED remains off, there is probably an abnormality in the output section.

**■ Solution (Check of input condition)**

Clarify the situation in the following procedure.

1. Check if the input indicator LEDs of the unit are on.  
When the LEDs are off, go to the next step. When they are on, go to step "Step 3".
2. Check the wiring state of the input device such as looseness of terminals.  
If the LED of the unit turns on in this processing, under capacity of power supply is possible. Review the power supply design.
3. Check if the voltage is properly applied to the input terminals.  
If the applied voltage is correct, there is probably an abnormality in the input part of the unit. If the correct voltage is not applied, there is probably an abnormality in the power supply or the input device.
4. Monitor the input state using the tool software.  
If the monitor state is off, there is probably an abnormality in the input part of the unit.

## 10.2 What to Do If an Error Occurs

If the monitor state is on, review the program and correct it if necessary. When the input device uses the two-wire type sensor, there may be an influence of leakage current.

### Info.

- When reviewing the program, check the following items.
  1. Check for the duplicated use of output. Check if the output has been written.
  2. Check if the flow of the program has not been changed by a control instruction such as MC instruction or JP instruction.
  3. Check if the allocation in the I/O map matches the mounting state.

### 10.2.7 Communication Error Occurs (RS-232C)

#### ■ Object

Product no.	Communication interface	Control unit	Cassette	
		COM0	COM1	COM2
Control Unit standard equipment	RS-232C (3-wire) x 1 channels	•		
AFP0HCCS1	RS-232C (5-wire) x 1 channel		•	
AFP0HCCS2	RS-232C (3-wire) x 2 channel		•	•
AFP0HCCS1M1	RS-485 x 1 channel		•	
	RS-232C (3-wire) x 1 channel			•

(Note 1) The RS-232C port of AFP0HCCS1 is a 5-wire type, and the RS/CS control can be performed.

(Note 2) The both 1-channel RS-485 and 1-channel RS-232C (3-wire type) can be used for AFP0HCCS1M1.

#### ■ Situation

The connection or setting may be incorrect.

#### ■ Solution

1. Check the setting of the system register.

Check if the setting corresponding to the allocated communication port number is correct. When the PLC link, check if the link areas do not overlap.
2. Check if the CS signal is on.

When the three-wire type is used, connect the RS signal and CS signal, and turn on the CS signal. When the five-wire type is used, check the communication cassette LED and the RS signal of the destination device
3. Check the connection with the destination device.

Confirm that the SD terminal of the destination device is connected to the RD terminal of the PLC, and the RD terminal of the destination device is connected to the SD terminal of the PLC. Check that the both SG terminals are connected.

### 10.2.8 Communication Error Occurs (RS-485)

#### ■ Object

Product no.	Communication interface	Allocated communication port no.		
		Control unit	Cassette mounting part	
		COM0	COM1	COM2
AFP0HCCM1	RS-485 x 1 channel		•	
AFP0HCCS1M1	RS-485 x 1 channel		•	
	RC-232C x 1 channel			•

#### ■ Situation

The connection or setting may be incorrect.

#### ■ Solution

1. Check the setting of the system register.  
Check if the setting corresponding to the allocated communication port number is correct.  
When the PLC link, check if the link areas do not overlap.
2. Check if the terminal unit is correctly connected.  
Do not designate any unit other than those at both ends of the network as a terminal station.
3. Check if the transmission cables between the (+) transmission terminals and between the (-) transmission terminals of each device are securely connected.
4. Check if the transmission cables are within the specifications range.  
Use only one type of cable. Do not mix more than one type.

(MEMO)



# 11 Maintenance and Inspection

---

11.1 Handling of Backup Battery.....	11-2
11.1.1 Replacement of Backup Battery.....	11-2
11.1.2 Lifetime and Time for Replacement of Backup Battery .....	11-3
11.2 Inspection.....	11-4

## 11.1 Handling of Backup Battery

### 11.1 Handling of Backup Battery

#### 11.1.1 Replacement of Backup Battery

The backup battery of the FP0H Control Unit can be replaced while the power is on. The procedure for replacing the backup battery is as follows.

#### **i** Info.

- For the FP0H Control Unit, the battery can be replaced while power is on. If the battery is to be replaced while power is off, undertake replacement within 1 minutes from powering off, after supplying power for at least 5 minutes, in order to charge the built-in capacitor. If the built-in capacitor has not been sufficiently charged, calendar timer data may become indefinite. Make sure that the battery connector cable is not pinched by the cover.

#### ■ Type of backup battery (sold separately)

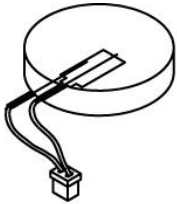
Appearance	Item name	Specifications	Product no.
	Backup battery	With a connector	AFPX-BATT

#### ■ Number of installed batteries

For the FP0H, only one battery is installed.

### **1 2** Procedure

1. Supply power to the control unit for more than five minutes.  
Charge the built-in capacitor to retain the contents of the memory during the replacement of the battery.
2. Turn off the power.
3. Open the cover.
4. Remove the used battery.
5. Install a new battery within one minute after turning off the power.
6. Close the cover.



Do not apply an excessive force to the card cover when opening or closing it or when the cover is left open. Otherwise, the cover attachment part will be deformed to cause malfunction in the cover recognition switch mounted inside the product.

---

**REFERENCE**

---

## 5.2.1 Installation of Backup Battery

**11.1.2 Lifetime and Time for Replacement of Backup Battery**

**■ Lifetime of backup battery**

Type of control unit	Lifetime of backup battery	Remark
C32ET/C32EP	5 years or more	When operating 8 hours a day
C32T/C32P		

(Note 1) The battery life is the value when no power at all is supplied. Note that the lifetime in actual use may be shorter than the typical lifetime depending on the use conditions.

**■ How to check the replacement time of the backup battery**

When using a backup battery, take either one of the following measures so that the replacement time of the backup battery can be checked.

- Enable system register No.4 "Alarm Battery Error".

If the system register No. 4 "Alarm Battery Error" is enabled, the "ERR/ALM" LED of the Control Unit will flash when the backup battery voltage drops and a battery error is detected.

- Create a program that reports the error to the outside.

The special internal relays (R9005 and R9006) will go on if the backup battery voltage drops and a battery error is detected. Using the special internal relays, create a program for reporting the error to the outside.

 **Note**

- The special internal relays (R9005 and R9006) will be on when a backup battery error is detected regardless of the setting of the system register.

**■ Replacement of the backup battery**

- Although data will be retained for about a week after the detection of backup battery error without power, the battery should be replaced as soon as possible.
- In consideration of the replacement time, have a spare backup battery in advance.



- If a week has passed without power after the special internal relays (R9005 and R9006) turned on or the "ERR/ALM" LED of the control unit flashed, retained memory data may be lost.
- Regardless of time passed from detection of a backup battery error, supply power to the control unit for at least five minutes before replacing the backup battery.

## 11.2 Inspection

### 11.2 Inspection

In order to use the unit in the optimal conditions, ensure routine/periodic inspection.

#### ■ Inspection item

Inspection item	Description	Criterion	Related page
Power supply	Check the lighting state of the "RUN/PROG." LED of the control unit.	Normal when "either "RUN or PROG." LED is on".	"P.2-5"
Display of the operation monitor LEDs	Check the RUN mode indicator LED.	On in RUN mode.	"P.2-5"
	Check the "ERR/ALM" LED.	Normally "off".	
Installation	Installation to the DIN rail (Is there any looseness?) Is there any looseness of the unit?	The unit should be securely installed.	"P.5-8"
Connection state	Loose terminal screw Proximity to a solderless terminal Loose connector	There should be no looseness. Locking should be on. They are locked. There should be no looseness in the connector part.	"P.5-9"to"P.5-14"
Power supply voltage of the unit	Voltage between terminals	24V DC	"P.5-10"
Power supply voltage of the I/O circuit	Supplied voltage	24V DC	"P.2-8", "P.3-3"
Usage conditions	Ambient temperature / in-board temperature Ambient humidity / in-board humidity Ambient air	0 to +55 °C 10 to 95% RH Free from excessive dust and corrosive gases	"P.5-2"
Backup battery	Backup battery for the control unit	Periodic replacement	"P.11-2"to"P.11-3"

# 12 Specifications

---

12.1 Control Unit Specifications.....	12-2
12.1.1 General Specifications .....	12-2
12.1.2 Performance Specifications .....	12-4
12.2 Communication Function Specifications .....	12-8
12.2.1 Communication Specifications of Control Unit.....	12-8
12.2.2 Communication Cassette Specifications.....	12-9
12.3 Operation Memory Area.....	12-11
12.4 List of System Registers .....	12-13
12.5 List of Special Relays.....	12-22
12.6 List of Special Data Registers.....	12-43
12.7 List of Basic Instructions .....	12-63
12.8 List of High-level Instructions .....	12-69
12.9 List of Error Codes.....	12-81
12.9.1 List of Syntax Check Errors .....	12-81
12.9.2 Self-diagnostic Errors.....	12-82
12.9.3 List of MEWTOCOL-COM Communication Error Codes .....	12-84
12.10 Dimensions .....	12-86
12.10.1 AFP0HC32T/AFP0HC32P .....	12-86
12.10.2 AFP0HC32ET/AFP0HC32EP .....	12-86

## 12.1 Control Unit Specifications

### 12.1 Control Unit Specifications

#### 12.1.1 General Specifications

##### ■ General specifications

Item	Specifications	
Rated voltage	24 V DC	
Operating voltage range	20.4 to 28.8 V DC	
Momentary power off time	4 ms (20.4 V DC), 10 ms (24.0 V DC or more)	
Operating ambient temperature	0 to +55 °C	
Storage ambient temperature	-40 to +70 °C	
Operating ambient humidity	10 to 95 %RH (at 25 °C, non-condensing)	
Storage ambient humidity	10 to 95 %RH (at 25 °C, non-condensing)	
Breakdown voltage (Detection current 5 mA)	All of the input and output terminals - All of the power supply terminals and function earths All of the input terminals - All of the output terminals	500V AC for 1 minute
Insulation resistance (Test voltage: 500V DC)	All of the input and output terminals - All of the power supply terminals and function earths All of the input terminals - All of the output terminals	100 M or more
Vibration resistance	Conforming to JISB3502 and IEC61131-2. 5 to 8.4 Hz, 3.5-mm single amplitude 8.4 to 150 Hz, Acceleration 9.8 m/s <sup>2</sup> 10 sweeps each X, Y and Z directions (1 octave/min)	
Shock resistance	Conforming to JISB3502 and IEC61131-2. 147 m/s <sup>2</sup> , 4 times in the X, Y, Z directions	
Noise resistance	1000 V[P-P] with pulse widths of 50 ns and 1us (based on in-house measurements) (Power supply terminal)	
Environment	Free from corrosive gases and excessive dust.	
EU Directive applicable standard	EMC Directive: EN61131-2, RoHS Directive: EN50581	
Overvoltage category	Category II	
Pollution degree	Pollution level 2	

### ■ List of consumption current

Unit type		Consumption current of Control unit (24 V DC)	Increase amount of current	Consumption current of Expansion unit (24 V DC)
Control unit alone	AFP0HC32T	140mA or less	—	—
	AFP0HC32P			
	AFP0HC32ET	170mA or less		
	AFP0HC32EP			
With Expansion unit	AFP0HXY64D2T	—	35 mA or less	—
	AFP0HXY64D2P		50mA or less	20mA or less
	AFP0HPG01T			
	AFP0HPG01L		70mA or less	35mA or less
	AFP0HPG02T			
	AFP0HPG02L			
	AFP0HM4N		90mA or less	—
AFP0HM8N				
With Extension cassette	AFP0HCCS1	—	10mA or less	—
	AFP0HCCS2			
	AFP0HCCM1		30mA or less	
	AFP0HCCS1M1			

(Note 1) For the details of the consumption currents of FPsigma Expansion Unit and FP0/FP0R Expansion Unit, refer to respective specifications and manuals.

### ■ Weight

Unit type		Weight (main unit)
Control unit	AFP0HC32T	Approx. 110 g
	AFP0HC32P	
	AFP0HC32ET	Approx. 130 g
	AFP0HC32EP	
Expansion unit	AFP0HXY64D2T	Approx. 100 g
	AFP0HXY64D2P	
	AFP0HPG01T	Approx. 75 g
	AFP0HPG01L	
	AFP0HPG02T	Approx. 80 g
	AFP0HPG02L	

## 12.1 Control Unit Specifications

Unit type		Weight (main unit)
	AFP0HM4N	Approx. 80 g
	AFP0HM8N	
Extension cassette	AFP0HCCS1	Approx. 10 g
	AFP0HCCS2	Approx. 10 g
	AFP0HCCM1	Approx. 10 g
	AFP0HCCS1M1	Approx. 10 g

### 12.1.2 Performance Specifications

Item		Specifications									
		Type without Ethernet function	Type with Ethernet function								
		C32T/C32P	C32ET/C32EP								
No. of controllable I/O points	Control unit	32 points (Input: 16 points, Output: 16 point)									
	With Expansion unit	Max. 384 points									
Programming method/Control method		Relay symbol/Cyclic operation									
Program memory		Built-in Flash ROM (Backup battery is not required.)									
No. of instructions	Basic instructions	Approx. 120									
	High-level instructions	Approx. 240	Approx. 270								
Program capacity <sup>(Note 1)</sup>		24K / 32K steps	24K / 32K / 40K / 64K steps								
		It can be selected by the system register no. 0. When the program capacity is changed, the number of usable data register (DT) words also varies.									
		<table border="1"> <thead> <tr> <th>Program capacity</th> <th>No. of DT words</th> </tr> </thead> <tbody> <tr> <td>24k steps</td> <td>65533 words</td> </tr> <tr> <td>32k steps (Default)</td> <td>32765 words (Default)</td> </tr> <tr> <td>40k steps</td> <td>24573 words</td> </tr> <tr> <td>64k steps</td> <td>12285 words</td> </tr> </tbody> </table>	Program capacity	No. of DT words	24k steps	65533 words	32k steps (Default)	32765 words (Default)	40k steps	24573 words	64k steps
Program capacity	No. of DT words										
24k steps	65533 words										
32k steps (Default)	32765 words (Default)										
40k steps	24573 words										
64k steps	12285 words										
Operation speed		<p><b>Basic instruction (NOT:/)</b>            Approx. 10 ns/step (up to 10 k steps)            Approx. 0.18 μs/step (from 10 k steps)</p> <p><b>Basic instruction (ST)</b>            Approx. 40 ns/step (up to 10 k steps)            Approx. 0.65 μs/step (from 10 k steps)</p> <p><b>High-level instruction (F0MV)</b>            Approx. 0.14 μs/step (up to 10 k steps)</p>									



## 12.1 Control Unit Specifications

Item		Specifications		
		Type without Ethernet function	Type with Ethernet function	
		C32T/C32P	C32ET/C32EP	
		Approx. 1.2 μs/step (from 10 k steps)		
Base scan time I/O refresh + base time		Control Unit alone: Approx. 40 μs or less + FP0/FP0R Expansion Unit refresh time <sup>(Note 2)</sup>	Control Unit alone: Approx. 100 μs or less + FP0/FP0R Expansion Unit refresh time <sup>(Note 2)</sup>	
Operation memory	Relay	External input (X) <sup>(Note 3)</sup> <sup>(Note 5)</sup>	1760 points (X0 to X109F)	
		External output (Y) <sup>(Note 3)</sup> <sup>(Note 5)</sup>	1760 points (Y0 to Y109F)	
		Internal relay (R) <sup>(Note 5)</sup>	4096 points (R0 to R255F) or 8192 points (R0 to R511F) <sup>(Note 6)</sup>	8192 points (Fixed) (R0 to R511F)
		Timer/Counter <sup>(Note 4)</sup>	1024 points (1008 points for Timer: T0 to T1007, 16 points for Counter: C1008 to C1023) Timer: Can be measured up to (in 1 msec / 10 msec / 100 msec / 1 sec unit) x 32767. Counter: Can be measured up to 1 to 32767.	
		Link relay (L)	2048 points (L0 to L127F)	
		Special internal relay (R)	800 points (R9000 to R951F)	
Operation memory	Memory area	Data register (DT) <sup>(Note 7)</sup>	32765 words (DT0 to DT32764) 65533 words (DT0 to DT65532)	12285 words (DT0 to DT12284) 24573 words (DT0 to DT24572) 32765 words (DT0 to DT32764) 65533 words (DT0 to DT65532)
		Special data register (DT)	1000 words (DT90000 to DT90999) <sup>(Note 5)</sup>	
		Link data register (LD)	256 words (LD0 to LD255)	
		Index register (I)	14 words (I0 to ID)	
Differential points (DF, DF/, DF1)		Points for program capacity		
Master control relay points		256 points		
No. of labels (JP and LOOP)		256 points		
No. of step ladders		1000 steps		
No. of subroutines		500 subroutines		
Interrupt program (INT)		9 programs 8 input programs (INT0 to INT7), 1 periodical program (INT24)		
Sampling trace <sup>(Note 8)</sup>		Available Sampling by commands/Sampling at regular time intervals (For one sampling: 16 bits + 3 words) 1000 samples		
Comment storage		All comments including I/O comments, explanatory notes, interlinear comments can be stored. (Backup battery is not necessary: 1M bytes)		
PLC link function		Max. 16 units, link relay: 1024 points, link register: 128 words (Data transfer and remote programming is not available)		

## 12.1 Control Unit Specifications

Item	Specifications	
	Type without Ethernet function	Type with Ethernet function
	C32T/C32P	C32ET/C32EP
Constant scan	Available (0 msec to 600 msecs *)	
Security Function	Password (32-digit), Upload protection	
Program protection function	Available	
Self-diagnostic unction	Such as watchdog timer, program syntax check	
Rewriting in RUN mode	Available	
SD card function	Not available	SD card project copy Logging trace function <sup>(Note 8)</sup> File access by instructions File transfer with FTP server/client function
Transfer between memories	Available (Internal memory (between ROM and RAM))	
High-speed counter <sup>(Note 9)</sup>	Single-phase 4 channels (Max. 100kHz for each input) or 2-phase 2 channels (Max. 50kHz for each input)	
Pulse output <sup>(Note 9)</sup>	4 channels (Max. 100 kHz for each axis)	
PWM output <sup>(Note 9)</sup>	4 channels (1 Hz to 70 kHz: Resolution of 1000 / 70.001 kHz to 100 kHz: Resolution of 100)	
Pulse catch input Interrupt input	8 points (Input of Control Unit: 8 points: X0 to X7)	
Periodical interrupt	0.1 ms to 30 s	
Potentiometer (Volume) input	2 points (Resolution: 12 bits (K0 to K4000)) <sup>(Note 10)</sup>	Not available
Input time constant processing	Available	
Clock/calender <sup>(Note 11)</sup>	Year (Last two numbers), month, day, hour (24-hour), minute, second and day of the week	
Memory backup <sup>(Note 12)</sup>	Backup by P13 instruction	All data register areas
	Automatic backup when power is cut off	Counter: 16 points, Internal relay: 128 points, Data register: 315 words
Battery backup (Only when installing a backup battery)	Hold areas or non-hold areas can be specified by setting the system registers no. 6 to no. 13. (It is also possible to make the setting for hold all points.)	
Battery lifetime	5 years or more in the actual use condition (operating 8 hours a day)	

(Note 1) For the FPsigma mode, only 24K or 32K steps can be selected regardless of models.

(Note 2) Breakdown of the refresh time of FP0/FP0R Expansion Unit

8-point unit	No. of units used x 0.8ms
--------------	---------------------------

16-point unit	No. of units used x 1.0ms
32-point unit	No. of units used x 1.3ms
64-point unit	No. of units used x 1.9ms

- (Note 3) The number of points actually available for use is determined by the hardware configuration.
- (Note 4) The number of points can be increased by using the auxiliary timer (F137).
- (Note 5) Compatible specifications with FPsigma is available.
- (Note 6) "0:4096 points or 1:8192 points" can be selected by the setting of the system register no. 1 (internal relay capacity).
- (Note 7) The capacity of data registers (DT) can be selected by the setting of the system register no. 0 (program capacity). For the FPsigma mode, only 32765 or 65533 words can be selected.
- (Note 8) The logging trace and sampling trace functions cannot be used simultaneously.
- (Note 9) This specification is applied when the rated input voltage is 24 V DC and the temperature is 25 °C. The maximum frequency may decrease depending on the applied voltage, ambient temperature and usage condition. The maximum frequency varies depending on the use. For the FPsigma mode, high-speed counter (4 channels), pulse output (2 channels), and PWM output (2 channels) are available.
- (Note 10) For the FPsigma mode, the range is K0 to K1000.
- (Note 11) Precision of the clock/calendar (Difference less than  $\pm 90$  seconds per month at 25 °C) Periodically set the clock/calendar to the right time for the system in which clock error is a problem.  
When the battery is not mounted, the calendar information will be erased when the power supply turns off. The date and time needs to be set when the power is turned on.
- (Note 12) Writing of the memory backup (backup by P13 instruction and automatic backup when power is cut off) can be performed within 10,000 times. Hold areas or non-hold areas can be specified by setting the system registers.

## 12.2 Communication Function Specifications

### 12.2 Communication Function Specifications

#### 12.2.1 Communication Specifications of Control Unit

##### ■ USB port (For tool software)

Item	Specifications
Standard	USB2.0 FULL SPEED (USB miniB type)
Communication functions	MEWTOCOL-COM (slave)

##### ■ COM0 port

Item	Specifications	
Interface	RS-232C (3-wire) (Non-isolated) x 1 channel	
Transmission distance	15 m	
Communication mode	1:1 communication	
Communication method	Half-duplex transmission	
Synchronous method	Start stop synchronous system	
Baud rate	1200, 2400, 4800, 9600, 19200, 38400, 57600, 115200, 230400 bit/s (Note 1)	
Communication format	Data length	7 bits/8 bits
	Parity	None/Even/Odd
	Stop bit	1 bit/2 bits
	Start code	STX/No STX
	End code	CR/CR+LF/None/ETX/Time (0 to 100.00 ms)
Data transmission order	Transmits from bit 0 character by character.	
Communication functions	MEWTOCOL-COM (master/slave) (computer link), PLC link MODBUS-RTU (Master/Slave), General-purpose communication	

(Note 1) Baud rate, transmission format, and applications of communication should be set using the tool software.

(Note 2) When communication is performed at a baud rate of 38,400 bit/s or higher, use the cable not longer than 3 m. For wiring the RS-232C, a shielded wire must be used to increase noise suppression. For wiring the RS-232C, a shielded wire must be used to increase noise suppression.

(Note 3) When connecting a commercially available device, please confirm operation using the actual device.

##### ■ LAN communication port (C32ET/C32EP)

Item	Specifications
Interface	100BASE-TX / D10BASE-TX
Baud rate	100Mbps/10Mbps automatic negotiation (Note 1)
Transmission system	Baseband

## 12.2 Communication Function Specifications

Item	Specifications
Cable total length	100m (500 m when using a repeater)
Communication cable	UTP cable (Category 5)
No. of simultaneous connections	Max. 10 (System connections: 1, User connections: 9)
Communication protocol	TCP/IP, UDP
Address family	Supports IPv4.
DNS	Supports name server.
DHCP	Automatically acquire IP address
FTP server / client	Server function: File transmission, No. of users: 1 Client function: Data and file transmission FTPS(TLS1.1/1.2) <sup>(Note 2)</sup>
SNTP	Time adjustment function
General-purpose communication	4 k bytes per connection (Transmission: 2 K bytes, Reception: 4 K bytes)
Dedicated communication	EtherNet/IP MEWTOCOL-COM (master/slave) (Computer link) MODBUS-TCP (master/slave) MEWTOCOL-DAT (master/slave) General-purpose communication MC protocol <sup>(Note 3)</sup> (master/slave)

(Note 1) Switching between different speeds is done automatically by auto negotiation function.

(Note 2) Only an explicit mode is supported.

(Note 3) MC protocol is an abbreviation for MELSEC Communication Protocol, and MELSEC is a registered trademark of Mitsubishi Electric Corporation. Only QnA compatible 3E frame and binary (bulk read and bulk write) can be used.

### 12.2.2 Communication Cassette Specifications

#### ■ RS-232C / RS-485 interface

Item	Specifications			
	AFP0HCCS1	AFP0HCCS2	AFP0HCCM1	AFP0HCCS1M1
Interface	RS-232C (5-wire type) x 1 channel (Non-isolated) <sup>(Note 1)</sup>	RS-232C (3-wire type) x 2 channels (Non-isolated)	RS-485 x 1 channel (Isolated) <sup>(Note 2)</sup>	RS-485 x 1 channel (Isolated) RS-232C (3-wire type) x 1 channel (Non-isolated) <sup>(Note 2)</sup>
Transmission distance	RS-232C: Max. 15 m <sup>(Note 3)</sup> RS-485: Max. 1200 m <sup>(Note 4) (Note 5)</sup>			
Baud rate	1200, 2400, 4800, 9600, 19200, 38400, 57600, 115200, 230400 bit/s			

## 12.2 Communication Function Specifications

Item	Specifications			
	AFP0HCCS1	AFP0HCCS2	AFP0HCCM1	AFP0HCCS1M1
Communication method	Half-duplex transmission			
Synchronous method	Start stop synchronous system			
Communication format	Data length: 7 bits/8 bits, Stop bit: 1 bit/2 bits, Parity: None/Odd/Even, Start code: STX/No STX, End code: CR/CR+LF/None/ETX/Time (0 to 100.00 ms)			
Data transmission order	Transmits from bit 0 character by character.			
Communication function and no. of connected units	PLC Link: Max. 16 units MEWTOCOL-COM (Master/Slave): Max. 99 units MODBUS RTU (Master/Slave): Max. 99 units General-purpose communication: Max. 99 units			

- (Note 1) When using it as a 3-wire type, short-circuit the RS-CS terminal.
- (Note 2) When connecting a commercially available device that has an RS-485 interface, please confirm operation using the actual device. In some cases, the number of units, transmission distance, and baud rate vary depending on the connected device.
- (Note 3) When communication is performed at a baud rate of 38400 bit/s or higher, use the cable not longer than 3 m. For wiring the RS-232C, a shielded wire must be used to increase noise suppression.
- (Note 4) The transmission distance is limited by the baud rate and the number of connected units when setting RS-485 as follows. For the baud rate of 38400 bit/s or less, the distance is up to 1200 m, and the number of connected units is 99. When using in combination with the C-NET adapter, the maximum number of connected units is limited to 32, and the baud rate is limited to 19200 bit/s or less.

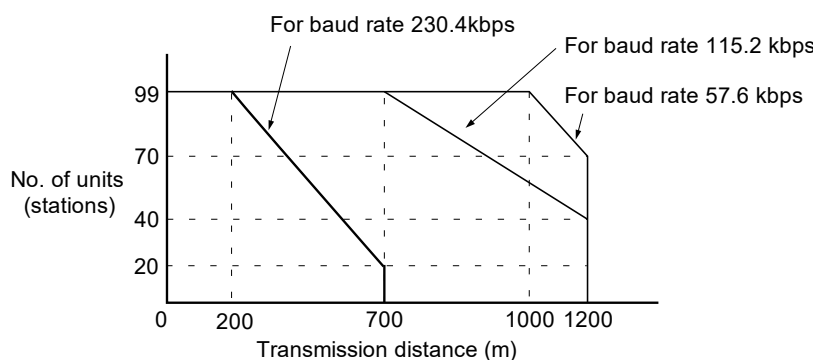

- (Note 5) The converter SI-35 manufactured by Lineeye Co., Ltd. is recommendable for the RS-485 at the computer side.

## 12.3 Operation Memory Area

Item		Specifications	
		Type without Ethernet function	Type with Ethernet function
		C32T/C32P	C32ET/C32EP
Relay	External input (X) <sup>(Note 1)</sup> <sup>(Note 3)</sup>	1760 points (X0 to X109F)	
	External output (Y) <sup>(Note 1)</sup> <sup>(Note 3)</sup>	1760 points (Y0 to Y109F)	
	Internal relay (R) <sup>(Note 3)</sup>	4096 points (R0 to R255F) or 8192 points (R0 to R511F) <sup>(Note 4)</sup>	8192 points (Fixed) (R0 to R511F)
	Timer/Counter (T/C) <sup>(Note 2)</sup>	1024 points (1008 points for Timer: T0 to T1007, 16 points for Counter: C1008 to C1023) Timer: Can be measured up to (in 1 msec / 10 msec / 100 msec / 1 sec unit) x 32767. Counter: Can be measured up to 1 to 32767.	
	Link relay (L)	2048 points (L0 to L127F)	
	Special internal relay (R)	800 points (R9000 to R951F)	
Memory area	External input (WX) <sup>(Note 1)</sup>	110 words (WX0 to WX109)	
	External output (WY) <sup>(Note 1)</sup>	110 words (WY0 to WY109)	
	Internal relay (WR)	256 words (WR0 to WR255) or 512 words (WR0 to WR511) <sup>(Note 3)</sup>	512 words (WR0 to WR511)
	Link relay (WL)	128 words (WL0 to WL127)	
	Data register (DT) <sup>(Note 5)</sup>	32765 words (DT0 to DT32764) 65533 words (DT0 to DT65532)	12285 words (DT0 to DT12284) 24573 words (DT0 to DT24572) 32765 words (DT0 to DT32764) 65533 words (DT0 to DT65532)
	Special data register (DT) <sup>(Note 3)</sup>	1000 words (DT90000 to DT90999)	
	Link data register (LD)	256 words (LD0 to LD255)	
	Timer/Counter set value area	1024 words (SV0 to SV1023)	
	Timer/counter elapsed value area (EV)	1024 words (EV0 to EV1023)	
Index register (I)	14 words (I0 to ID)		

(Note 1) The number of points actually available for use is determined by the hardware configuration.

(Note 2) The points of the timer/counter can be set by the system register no. 5. The numbers in the above table are the case of the default settings. Also, the number of points can be increased by using the auxiliary timer (F137).

(Note 3) Compatible specifications with FPsigma is available.

(Note 4) "0:4096 points or 1:8192 points" can be selected by the setting of the system register no. 1 (internal relay capacity).

(Note 5) The capacity of data registers (DT) <Table below> can be selected by the setting of the system register no. 0 (program capacity).

For the FPsigma mode, only the program capacity of 24 or 32 can be selected regardless of models.

### 12.3 Operation Memory Area

---

Type	System register no. 0 Program capacity	Data register capacity
C32T/C32P	24	65533 words
	32	32765 words
C32ET/C32EP	24	65533 words
	32	32765 words
	40	24573 words
	64	12285 words



## 12.4 List of System Registers

### ■ Memory allocation

No.	Name	Default	Setting range and description
0	Sequence program area size <sup>(Note 1)</sup> <sup>(Note 2)</sup>	32	[FP0H mode] C32: 24K, 32K words C32E: 24K, 32K, 40K, 64K words [FPsigma mode] 24K, 32K words
1	Internal relay area size <sup>(Note 1)</sup>	8192	C32: 4096, 8192 C32E: 8192 (Fixed)

(Note 1) The system register no. 0 (Sequence program area size) and no. 1 (Internal relay area size) can be set only in off-line editing. To make the setting effective, you need to download it to the control unit.

(Note 2) System register no.0: if you change the sequence program area capacity, the capacity of the data register DT will be changed.

For the FPsigma mode, only 24K or 32K words can be selected.

### ■ Hold / Non-hold 1

No.	Name	Default	Setting range and description
5	Counter starting address	1008	0 to 1024
6	Hold type area starting address for timer/counter	1008	0 to 1024
7	Starting word No. of internal relay hold area <sup>(Note 1)</sup>	[FP0H mode]	
		248	0 to 256
		504	0 to 512
		[FPsigma mode]	
		248 (Fixed)	0 to 256, 0 to 512
8	Hold type area starting address for data registers <sup>(Note 2)</sup>	[FP0H mode] C32:	
		32450	0 to 32765
		65218	0 to 65533
		[FP0H mode] C32E:	
		11970	0 to 12285
		24258	0 to 24573
		32450	0 to 32765
65218	0 to 65533		
		[FPsigma mode]	
		32710 (Fixed)	0 to 32765 0 to 65533
14	Holding the step ladder	Non-hold	Hold/Non-hold
4	Leading edge detection of the differential instruction during MC holds the previous value	Hold	Hold/Non-hold

## 12.4 List of System Registers

(Note 1) The default and setting range of System register No. 7 differ depending on the value of System register No.1.

System register No.1	System register No.7		
	Default		Setting range
	FP0H mode	FPsigma mode	
4096 points	248	248 (Fixed)	0 to 256
8192 points	504		0 to 512

(Note 2) The default and setting range of System register No. 8 differ depending on the value of System register No.0.

System register No.0		System register No.8		
		Default		Setting range
		FP0H mode	FPsigma mode	
24Kstep		65218	32710 (Fixed)	0 to 65533
32Kstep		32450		0 to 32765
40Kstep	C32ET only	24258	No setting	0 to 24573
64Kstep		11970		0 to 12285

### ■ Hold / Non-hold 2

No.	Name	Default	Setting range and description
10	Hold type area starting word address setting for link relays for PLC link W0-0	64	0 to 64
11	Hold type area starting word address setting for link relays for PLC link W0-1	128	64 to 128
12	Hold type area starting word address setting for link data registers for PLC link W0-0	128	0 to 128
13	Hold type area starting word address setting for link data registers for PLC link W0-1	256	128 to 256

### ■ Action on Error

No.	Name	Default	Setting range and description
20	Disable settings for duplicated output	Disable	Disable/Enable
23	Stop operation when an I/O verification error occurs	Stop	Stop/Run
24	Stop operation when configuration data error/initialization request error occurs (C32ET/C32EP only)	Stop	Stop/Run
25	Stop operation when positioning operation error occurs	Run	Stop/Run

No.	Name	Default	Setting range and description
26	Stop operation when calculating error occurs	Stop	Stop/Run
27	Stop operation when network error occurs (C32ET/C32EP only)	Stop	Stop/Run
4	Alarm the battery abnormality	No	No: The self-diagnostic error is not notified in case of battery error, and the "ERR/ALM" LED does not flash. Yes: The self-diagnostic error is notified in case of battery error, and the "ERR/ALM" LED flashes.

### ■ Time setting

No.	Name	Default	Setting range and description
31	Waiting time for managing multiple frame	6500 ms	10 to 81900 ms (In 2.5 ms unit)
32	SEND / RECV / RMRD / RMWT instruction waiting time	10000 ms	10 to 81900 ms (In 2.5 ms unit)
34	Constant scan time	Normal scan	0: Normal scan (in 0.5 ms unit) 0 to 600 ms: Scan at a specified time interval
37	Task time priority setting <a href="#">(Note 1)</a>	Standard	Normal/Operation

(Note 1) It is available only in RUN mode. The setting is always "Normal" in PROG. mode.

By selecting "Operation", the time taken for the communication processing is reduced for one port per scan. The operation processing takes priority.

### ■ PLC link W0-0 setting

No.	Name	Default	Setting range and description
40	Size of link relays	0	0 to 64 words
41	Size of link data registers	0	0 to 128 words
42	Send area starting word address of link relay	0	0 to 63
43	Size of link relays used for send area	0	0 to 64 words
44	Send area starting address of link data register	0	0 to 127
45	Size of link data registers used for send area	0	0 to 127 words
46	PLC link switch flag	Normal	Normal/Reverse
47	MEWNET-W0 PLC link max. station no.	16	1 to 16
48	PLC link baud rate <a href="#">(Note 1)</a>	115200bps	115200 bps/230400 bps

(Note 1) The system register no. 48 (PLC link baud rate) is set in the same dialog box for the COM0 port, COM1 port and COM2 port settings.

## 12.4 List of System Registers

### ■ PLC link W0-1 setting

No.	Name	Default	Setting range and description
50	Size of link relays	0	0 to 64 words
51	Size of link data registers	0	0 to 128 words
52	Send area starting word address of link relay	64	64 to 127
53	Size of link relays used for send area	0	0 to 64 words
54	Send area starting address of link data register	128	128 to 255
55	Size of link data registers used for send area	0	0 to 127 words
57	MEWNET-W0 PLC link max. station no.	16	1 to 16

### ■ Controller input settings (HSC/PLS)

No.	Name	Default	Setting range and description
400	HSC operation mode settings (X0 to X2)	CH0: Not Set X0 as High Speed Counter	Not Set X0 as High Speed Counter 2 phase input (X0, X1) 2 phase input (X0, X1) Reset input (X2) Addition input (X0) Addition input (X0) Reset input (X2) Subtraction input (X0) Subtraction input (X0) Reset input (X2) One input (X0, X1) One input (X0, X1) Reset input (X2) Direction distinction (X0, X1) Direction distinction (X0, X1) Reset input (X2) J-point positioning start input of pulse output CH0 (X0)
		CH1: Not Set X1 as High Speed Counter	Not Set X1 as High Speed Counter Addition input (X1) Addition input (X1) Reset input (X2) Subtraction input (X1) Subtraction input (X1) Reset input (X2) J-point positioning start input of pulse output CH1 (X1)
401	HSC operation mode settings (X3 to X5)	CH2: Not Set X3 as High Speed Counter	Not Set X3 as High Speed Counter 2 phase input (X3, X4) 2 phase input (X3, X4) Reset input (X5) Addition input (X3) Addition input (X3) Reset input (X5) Subtraction input (X3) Subtraction input (X3) Reset input (X5) One input (X3, X4) One input (X3, X4) Reset input (X5) Direction distinction (X3, X4)

No.	Name	Default	Setting range and description
			Direction distinction (X3, X4) Reset input (X5) J-point positioning start input of pulse output CH2 (X3)
		CH3: Not Set X4 as High Speed Counter	Not Set X4 as High Speed Counter Addition input (X4) Addition input (X4) Reset input (X5) Subtraction input (X4) Subtraction input (X4) Reset input (X5) J-point positioning start input of pulse output CH3 (X4)

(Note 1) "J-point positioning start input" for each channel can be selected only when "Table setting mode" is set in the system register no. 407.

### ■ Controller output settings (PLS/PWM) for FP0H mode

No.	Name	Default	Setting range and description
407	Positioning control mode setting	Table setting mode	Table setting mode, FPsigma compatible instruction mode
402 (Note 1) (Note 2)	Pulse/PWM output setting (Y0 to YC) When selecting "Table setting mode" in no. 407	CH0:	Normal output (Y0, Y1) WM output (Y0), Normal output (Y1) Pulse output [Table operation] (Y0, Y1)
		CH1:	Normal output (Y3, Y4) Normal output (Y3, Y4) PWM output (Y3), Normal output (Y4) Pulse output [Table operation] (Y3, Y4)
		CH2:	Normal output (Y8, Y9) Normal output (Y8, Y9) PWM output (Y8), Normal output (Y9) Pulse output [Table operation] (Y8, Y9)
		CH3:	Normal output (YB, YC) Normal output (YB, YC) PWM output (YB), Normal output (YC) Pulse output [Table operation] (YB, YC)
	Pulse/PWM output setting (Y0 to YC) When selecting "FPsigma compatible instruction mode" in no. 407	CH0:	Normal output (Y0, Y1) Normal output (Y0, Y1) Pulse output (Y0, Y1) PWM output (Y0), Normal output (Y1)
		CH1:	Normal output (Y3, Y4) Normal output (Y3, Y4) Pulse output (Y3, Y4) PWM output (Y3), Normal output (Y4)
		CH2:	Normal output (Y8, Y9) Normal output (Y8, Y9) Pulse output (Y8, Y9) PWM output (Y8), Normal output (Y9)
		CH3:	Normal output (YB, YC) Normal output (YB, YC) Pulse output (YB, YC) PWM output (YB), Normal output (YC)

## 12.4 List of System Registers

### ■ Controller output settings (PLS/PWM) for FPsigma mode

No.	Name	Default	Setting range and description
407 (Note 1)	Positioning control mode setting	FPsigma compatible instruction mode	FPsigma compatible instruction mode (Fixed)
402	Pulse/PWM output settings (Y0 to YC) (Note 2)	-	Not selectable

(Note 1) If the no. 407 (Positioning control start setting) is changed, the selection of the no. 402 (Pulse/PWM output setting) will be switched.

(Note 2) For using the pulse output [Table setting mode] function, pulse output function and PWM output function, the controller output setting must be set. The output specified for the pulse output and PWM output cannot be used as normal output.

### ■ Interrupt / pulse catch settings

No.	Name	Default	Setting range and description																
403 (Note 1)	Pulse catch input setting	Not set	<table border="1" style="margin-left: 20px;"> <tr> <td>X0</td><td>X1</td><td>X2</td><td>X3</td><td>X4</td><td>X5</td><td>X6</td><td>X7</td> </tr> <tr> <td><input type="checkbox"/></td><td><input type="checkbox"/></td><td><input type="checkbox"/></td><td><input type="checkbox"/></td><td><input type="checkbox"/></td><td><input type="checkbox"/></td><td><input type="checkbox"/></td><td><input type="checkbox"/></td> </tr> </table> Controller input The pressed contact is set as pulse catch input.	X0	X1	X2	X3	X4	X5	X6	X7	<input type="checkbox"/>	<input type="checkbox"/>	<input type="checkbox"/>	<input type="checkbox"/>	<input type="checkbox"/>	<input type="checkbox"/>	<input type="checkbox"/>	<input type="checkbox"/>
X0	X1	X2	X3	X4	X5	X6	X7												
<input type="checkbox"/>	<input type="checkbox"/>	<input type="checkbox"/>	<input type="checkbox"/>	<input type="checkbox"/>	<input type="checkbox"/>	<input type="checkbox"/>	<input type="checkbox"/>												
404 (Note 1)	Interrupt input settings	Not set	<table border="1" style="margin-left: 20px;"> <tr> <td>X0</td><td>X1</td><td>X2</td><td>X3</td><td>X4</td><td>X5</td><td>X6</td><td>X7</td> </tr> <tr> <td><input type="checkbox"/></td><td><input type="checkbox"/></td><td><input type="checkbox"/></td><td><input type="checkbox"/></td><td><input type="checkbox"/></td><td><input type="checkbox"/></td><td><input type="checkbox"/></td><td><input type="checkbox"/></td> </tr> </table> Controller input The pressed contact is set as interrupt input.	X0	X1	X2	X3	X4	X5	X6	X7	<input type="checkbox"/>	<input type="checkbox"/>	<input type="checkbox"/>	<input type="checkbox"/>	<input type="checkbox"/>	<input type="checkbox"/>	<input type="checkbox"/>	<input type="checkbox"/>
X0	X1	X2	X3	X4	X5	X6	X7												
<input type="checkbox"/>	<input type="checkbox"/>	<input type="checkbox"/>	<input type="checkbox"/>	<input type="checkbox"/>	<input type="checkbox"/>	<input type="checkbox"/>	<input type="checkbox"/>												

(Note 1) If the same input is set to the high-speed counter, pulse catch, and interrupt input, the priority order is as follows; 1. High-speed counter, 2. Pulse catch, 3. Interrupt input.

### ■ Interrupt edge setting

No.	Name	Default	Setting range and description																																
405 (Note 1)	Effective interrupt edge setting for controller input	Leading edge	<table border="1" style="margin-left: 20px;"> <tr> <td>X0</td><td>X1</td><td>X2</td><td>X3</td><td>X4</td><td>X5</td><td>X6</td><td>X7</td> </tr> <tr> <td><input type="checkbox"/></td><td><input type="checkbox"/></td><td><input type="checkbox"/></td><td><input type="checkbox"/></td><td><input type="checkbox"/></td><td><input type="checkbox"/></td><td><input type="checkbox"/></td><td><input type="checkbox"/></td> </tr> </table> Leading edge <table border="1" style="margin-left: 20px;"> <tr> <td>X0</td><td>X1</td><td>X2</td><td>X3</td><td>X4</td><td>X5</td><td>X6</td><td>X7</td> </tr> <tr> <td><input type="checkbox"/></td><td><input type="checkbox"/></td><td><input type="checkbox"/></td><td><input type="checkbox"/></td><td><input type="checkbox"/></td><td><input type="checkbox"/></td><td><input type="checkbox"/></td><td><input type="checkbox"/></td> </tr> </table> Trailing edge The pressed contacts are set as leading and trailing edges.	X0	X1	X2	X3	X4	X5	X6	X7	<input type="checkbox"/>	<input type="checkbox"/>	<input type="checkbox"/>	<input type="checkbox"/>	<input type="checkbox"/>	<input type="checkbox"/>	<input type="checkbox"/>	<input type="checkbox"/>	X0	X1	X2	X3	X4	X5	X6	X7	<input type="checkbox"/>	<input type="checkbox"/>	<input type="checkbox"/>	<input type="checkbox"/>	<input type="checkbox"/>	<input type="checkbox"/>	<input type="checkbox"/>	<input type="checkbox"/>
X0	X1	X2	X3	X4	X5	X6	X7																												
<input type="checkbox"/>	<input type="checkbox"/>	<input type="checkbox"/>	<input type="checkbox"/>	<input type="checkbox"/>	<input type="checkbox"/>	<input type="checkbox"/>	<input type="checkbox"/>																												
X0	X1	X2	X3	X4	X5	X6	X7																												
<input type="checkbox"/>	<input type="checkbox"/>	<input type="checkbox"/>	<input type="checkbox"/>	<input type="checkbox"/>	<input type="checkbox"/>	<input type="checkbox"/>	<input type="checkbox"/>																												

(Note 1) If the same input is set to the high-speed counter, pulse catch, and interrupt input, the priority order is as follows; 1. High-speed counter, 2. Pulse catch, 3. Interrupt input.

### ■ Time constant setting of controller input 1 / 2

No.	Name	Default	Setting range and description
430	Input X0 to X3	[FP0H mode]	None / 0.1 ms / 0.2 ms / 0.5 ms / 1 ms / 2 ms / 4 ms / 8 ms / 16 ms / 32 ms / 64 ms / 128 ms / 256 ms
431	Input X4 to X7	1 ms	
432	Input X8 to XB	[FPsigma mode]	
433	Input XC to XF	None	
438	Update inputs status when the power is turned on (Note 1)	After a time constant	After a time constant Immediately

(Note 1) Available on FP0H Ver.1.9 or later

### ■ COM0 / COM1 / COM2 port setting

No.	Name	Default	Setting range and description
410 411	Unit No.	1	1 to 99
412	Communication Mode	Computer Link	Computer Link General-purpose communication PLC Link MODBUS RTU
	Modem connection	Not execute	Execute/Not execute
413 414	Communication format	Data length: 8 bits Parity check: Odd Stop bit: 1	Character bit: 7 bits/8 bits Parity: None/Odd/Even Stop bit: 1/2 Terminator selection: Code/Time Terminator: CR/CR+LF/None/ETX Header: STX Not Exist./STX exists
415	Baud rate <sup>(Note 2)</sup> <sup>(Note 3)</sup> <sup>(Note 4)</sup>	9600 bps	2400 bps, 4800 bps, 9600 bps, 19200 bps, 38400 bps, 57600 bps, 115200 bps, 230400 bps
416	(COM1) Starting address for data received of serial data communication mode	0	0 to 65532 <sup>(Note 1)</sup>
417	(COM1) Buffer capacity setting for data received of serial data communication mode	2048	0 to 2048
418	(COM2) Starting address for data received of serial data communication mode	2048	0 to 65532 <sup>(Note 1)</sup>
419	(COM2) Buffer capacity setting for data received of serial data communication mode	2048	0 to 2048
420	(COM0) Starting address for data received of serial data communication mode	4096	0 to 65532 <sup>(Note 1)</sup>
421	(COM0) Buffer capacity setting for data received of serial data communication mode	2048	0 to 2048
424	(COM0) Terminator judgement time (x 0.01 ms)	0	0 or 1 to 10000 (0.01 ms to 100 ms) When terminator judgement time is 0, transmission time is that for approx. 4 bytes.
425	(COM1) Terminator judgement time (x 0.01 ms)	0	

## 12.4 List of System Registers

No.	Name	Default	Setting range and description
426	(COM2) Terminator judgement time (x 0.01 ms)	0	

(Note 1) The range of the system register no. 416/418/420 varies according to the value of the system register no. 0.

System registerNo.0 Sequence program area size	System register no. 416/418/420/422 Receive buffer starting address in general-purpose communication
24Kstep	0 to 65532
32Kstep	0 to 32764
40Kstep	0 to 24572
64Kstep	0 to 12284

(Note 2) System register no. 415 cannot be used to set the baud rate to 1200 bps. To set the baud rate to 1200 bps, use the SYS1 instruction.

(Note 3) If the baud rate is changed as below, communications passing through all COM ports will be reset.  
Baud rates of all COM ports: 4800 bps or higher ↔ Baud rates of any COM ports: 2400 bps or lower

(Note 4) If the baud rate of any of the COM ports is 2400 bps or lower, F-ROM access will slow down.  
Example) F12(ICRD) instruction, P13(ICWT) instruction, etc.

### ■ SD card setting (Type with Ethernet function)

No.	Name	Default	Setting range and description
440	SD card cover open/close detection	Detect	Detect/Not detect Detect: When the cover of the control unit is open, accessing the SD memory card is not allowed. Or the access is stopped. Not detect: Even when the cover of the control unit is open, accessing the SD memory card is allowed. However, if an SD memory card is removed/ inserted during the SD memory card access, the SD memory card or data may be damaged.
441	Allowed time of SD card task operation	10 ms	0.5 to 100 ms (In 0.5 ms unit)

### ■ Compatible mode

No.	Name	Default	Setting range and description
3	Compatible mode setting <sup>(Note 1)</sup>	FP0H mode (Note 2)	FP0H mode FPsigma mode

(Note 1) System register no.3 (compatibility mode settings) can be set only in off-line editing. To make the setting effective, you need to download it to the control unit.

(Note 2) If the PLC has been changed from FPsigma to another model, FPsigma mode is used by default.



**REFERENCE**

---

9.4 FPsigma Mode

---

## 12.5 List of Special Relays

### 12.5 List of Special Relays

#### WR900 (Specified in word unit)

Relay no.	Name	Description
R9000	Self-diagnostic error flag	Turns on when a self-diagnostic error occurs. - The self-diagnostic result is stored in DT90000.
R9001	Reserved for system	-
R9002	I/O unit error flag	Turns on when the I/O unit of FP0H/FPsigma Expansion Unit (left expansion) runs away. - The self-diagnostic error "E40: I/O error" occurs, and the corresponding bit turns on in DT90002.
R9003	Intelligent unit error flag	Turns on when the intelligent unit of FP0H/FPsigma Expansion Unit (left expansion) runs away. - The self-diagnostic error "E41: Special unit runaway" occurs, and the corresponding bit turns on in DT90006.
R9004	I/O verification error flag	Turns on when an I/O verification error is detected.
R9005	Backup battery error flag (current type)	Turns on when a battery error occurs. Even if you choose not to notify battery error in the system register, this is also ON when the battery runs out.
R9006	Backup battery error flag (hold)	Turns on when a battery error occurs. Even if you choose not to notify battery error in the system register, this is also ON when the battery runs out. Once a battery error has been detected, this is held even after recovery has been made. - It goes off if the power supply is turned off.
R9007	Operation error flag (hold) (ER flag)	Turns on when an operation error occurs after the unit has started operating, and remains on while the unit operation continues. - The address where the error occurred is stored in DT90017. (It indicates the first operation error that has occurred.)
R9008	Operation error flag (latest) (ER flag)	Turns on every time an operation error occurs. - The address where the operation error occurred is stored in DT90018. Every time a new error occurs, the data will be updated.
R9009	Carry flag (CY flag)	This flag is set when the operation result overflow or under flow occurs, or when performing a shift system instruction.
R900A	> flag	Executes a comparison instruction, and turns on if the result is larger.
R900B	= flag	Executes a comparison instruction, and turns on if the result is equal. Executes an operation instruction, and turns on if the operation result is '0'.
R900C	< flag	Executes a comparison instruction, and turns on if the result is smaller.
R900D	Auxiliary timer contact	Executes the auxiliary timer instruction (F137/F138), and turns on after the lapsed of a set time. Turns off when the execution condition turns to off.
R900E (R9130)	COM0 port communication error	Turns on if a communication error is detected when using the COM0 port.

## 12.5 List of Special Relays

Relay no.	Name	Description
R900F	Constant scan error flag	Turns on if the scan time exceeds the set time (system register no. 34) when performing the constant scan. It also turns on when 0 is set in the system register no. 34.

(Note 1) The same function is allocated to the special internal relay in parentheses.

### WR901 (Specified in word unit)

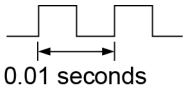
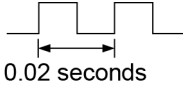
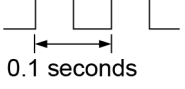
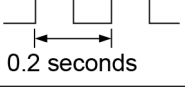
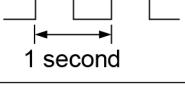
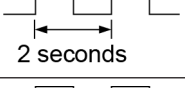
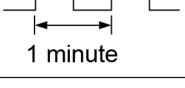
Relay no.	Name	Description
R9010	Always ON relay	Always on.
R9011	Always OFF relay	Always off.
R9012	Scan pulse relay	Turns on and off alternately at each scan.
R9013	Initial pulse relay (ON)	Turns on for only the first scan after operation (RUN) has been started, and turns off for the second and subsequent scans.
R9014	Initial pulse relay (OFF)	Turns off for only the first scan after operation (RUN) has been started, and turns on for the second and subsequent scans.
R9015	Step ladder Initial pulse relay (ON)	Turns on in the first scan only, following startup of any single process, during stepladder control.
R9016 to R9017	Reserved for system	-
R9018	0.01-sec clock pulse relay	Clock pulse with a 0.01-second cycle. 
R9019	0.02-sec clock pulse relay	Clock pulse with a 0.02-second cycle. 
R901A	0.1-sec clock pulse relay	Clock pulse with a 0.1-second cycle. 
R901B	0.2-sec clock pulse relay	Clock pulse with a 0.2-second cycle. 
R901C	1-sec clock pulse relay	Clock pulse with a 1-second cycle. 
R901D	2-sec clock pulse relay	Clock pulse with a 2-second cycle. 
R901E	1-min clock pulse relay	Clock pulse with a 1-minute cycle. 
R901F	Reserved for system	-

## 12.5 List of Special Relays

### WR902 (Specified in word unit)

Relay no.	Name	Description
R9020	RUN mode flag	Turns off while the mode selector is set to PROG. Turns on while the mode selector is set to RUN.
R9021 to R9025	Reserved for system	-
R9026	Message flag	Turns on when the message display instruction (F149) is executed.
R9027 to R9028	Reserved for system	-
R9029	Force flag	Turns on during forced on/off operation for input/output relays or timer/counter contacts.
R902A	Interrupt enable flag	Turns on while the external interrupt trigger is enabled.
R902B	Reserved for system	-
R902C	Sample point flag	Sampling by instruction = 0 Sampling at constant time intervals = 1
R902D	Sampling trace end flag	When the sampling operation stops = 1 When the sampling operation starts = 0
R902E	Sampling stop trigger flag	When the sampling stop trigger occurs = 1 When the sampling stop trigger stops = 0
R902F	Sampling enable flag	When sampling starts = 0 When sampling stops = 1

### WR903 (Specified in word unit)

Relay no.	Name	Description
R9030 to R9031	Reserved for system	-
R9032 (R9139)	COM1 port communication mode flag	Turns on when using the general-purpose communication function. Turns off when using a function other than the general-purpose communication.
R9033	Print instruction execution flag	Off: Not executed On: Being executed
R9034	Program edit flag in RUN mode	This is a special internal relay which turns on for only the first scan following the completion of rewriting in RUN mode.
R9035 to R9036	Reserved for system	-
R9037 (R9138)	COM1 port communication error flag	Turns on if a transmission error occurs when performing data communication. Turns off when a transmission request is made by the F159 (MTRN) instruction.
R9038 (R913A)	COM1 port reception done flag during general-purpose communication	Turns on when the end code is received in the general-purpose communication. Turns off when the transmission is requested in the general-purpose communication.

## 12.5 List of Special Relays

Relay no.	Name	Description
R9039 (R913B)	COM1 port transmission done flag during general-purpose communication	Turns on when the transmission ends in the general-purpose communication. Turns off when the transmission is requested in the general-purpose communication.
R903A	Control flag (CH0)	[FPsigma mode] Turns on when F165 (CAM0), F166 (HC1S) or F167 (HC1R) instruction is being executed, and turns off when it is complete. Turns on when outputting pulses by F171 (SPDH), F172 (PLSH), F173 (PWMH), F174 (SP0H) or F175 (SPSH) instruction.
R903B	Control flag (CH1)	[FPsigma mode] Turns on when F165 (CAM0), F166 (HC1S) or F167 (HC1R) instruction is being executed, and turns off when it is complete.
R903C	Control flag (CH2)	[FPsigma mode] Turns on when F165 (CAM0), F166 (HC1S) or F167 (HC1R) instruction is being executed, and turns off when it is complete. Turns on when outputting pulses by F171 (SPDH), F172 (PLSH), F173 (PWMH), F174 (SP0H) or F175 (SPSH) instruction.
R903D	Control flag (CH3)	[FPsigma mode] Turns on when F165 (CAM0), F166 (HC1S) or F167 (HC1R) instruction is being executed, and turns off when it is complete.
R903E (R9132)	COM0 port transmission done flag during general-purpose communication	Turns on when the end code is received in the general-purpose communication. Turns off when the transmission is requested in the general-purpose communication.
R903F (R9133)	COM0 port transmission done flag during general-purpose communication	Turns on when the transmission ends in the general-purpose communication. Turns off when the transmission is requested in the general-purpose communication.

(Note 1) R9030 to R903F will change even during one scan cycle. In addition, the same functions are allocated to the special internal relays in parentheses.

### WR904 (Specified in word unit)

Relay no.	Name	Description
R9040 (R9131)	COM0 port communication mode flag	Turns on when using the general-purpose communication function. Turns off when using a function other than the general-purpose communication function.
R9041 (R913E)	COM1 port PLC link flag	Turns on when using the PLC link function.
R9042 (R9141)	COM2 port communication mode flag	Turns on when using the general-purpose communication function. Turns off when using a function other than the general-purpose communication function.
R9043	Reserved for system	-
R9044	COM1 port	Indicates whether the F145 (SEND) or F146 (RCV) instruction can be executed or not for the COM1 port.

## 12.5 List of Special Relays

Relay no.	Name	Description
(R913C)	SEND/RECV instruction execution flag	OFF: Not executable (Instruction is being executed) ON: Executable
R9045 (R913D)	COM1 port SEND/RECV instruction execution end flag	Indicates the execution state of the F145 (SEND) or F146 (RECV) instruction for the COM1 port. OFF: Normal end ON: Abnormal end (Communication error occurs) The error code is stored in DT90124.
R9046	Reserved for system	-
R9047 (R9140)	COM2 port communication error flag	Turns on if a transmission error occurs when performing data communication. Turns off when a transmission request is made by the F159 (MTRN) instruction.
R9048 (R9142)	COM2 port reception done flag during general-purpose communication	Turns on when the end code is received in the general-purpose communication. Turns off when the transmission is requested in the general-purpose communication.
R9049 (R9143)	COM2 port transmission done flag during general-purpose communication	Turns on when the transmission ends in the general-purpose communication. Turns on when the transmission is requested in the general-purpose communication.
R904A (R9144)	COM2 port SEND/RECV instruction execution flag	Indicates whether the F145 (SEND) or F146 (RECV) instruction can be executed or not for the COM2 port. OFF: Not executable (Instruction is being executed) ON: Executable
R904B (R9145)	COM2 port SEND/RECV instruction execution end flag	Indicates the execution state of the F145 (SEND) or F146 (RECV) instruction for the COM2 port. OFF: Normal end ON: Abnormal end (Communication error occurs) The error code is stored in DT90125.
R904C to R904F	Reserved for system	-

(Note 1) R9040 to R904F will change even during one scanning cycle. In addition, the same functions are allocated to the special internal relays in parentheses.

### WR905 (Specified in word unit)

Relay no.	Name	Description
R9050	MEWNET-W0 PLC link transmission error flag	When using MEWNET-W0 Turns on when a transmission error occurs in the PLC link. Turns on when there is an error in the setting for the PLC link area.
R9051 to R905F	Reserved for system	-

### WR906 (Specified in word unit)

Relay no.	Name	Unit no.	Description
R9060	MEWNET-W0	Unit no. 1	Unit no. 1 When normally communicating in the PLC link mode: ON

## 12.5 List of Special Relays

Relay no.	Name	Description
		When stopping, a error occurs or the PLC link is not performed: OFF
R9061	Transmission assurance relay for PLC link 0	Unit no. 2 When normally communicating in the PLC link mode: ON When stopping, a error occurs or the PLC link is not performed: OFF
R9062		Unit no. 3 When normally communicating in the PLC link mode: ON When stopping, a error occurs or the PLC link is not performed: OFF
R9063		Unit no. 4 When normally communicating in the PLC link mode: ON When stopping, a error occurs or the PLC link is not performed: OFF
R9064		Unit no. 5 When normally communicating in the PLC link mode: ON When stopping, a error occurs or the PLC link is not performed: OFF
R9065		Unit no. 6 When normally communicating in the PLC link mode: ON When stopping, a error occurs or the PLC link is not performed: OFF
R9066		Unit no. 7 When normally communicating in the PLC link mode: ON When stopping, a error occurs or the PLC link is not performed: OFF
R9067		Unit no. 8 When normally communicating in the PLC link mode: ON When stopping, a error occurs or the PLC link is not performed: OFF
R9068		Unit no. 9 When normally communicating in the PLC link mode: ON When stopping, a error occurs or the PLC link is not performed: OFF
R9069		Unit no. 10 When normally communicating in the PLC link mode: ON When stopping, a error occurs or the PLC link is not performed: OFF
R906A		Unit no. 11 When normally communicating in the PLC link mode: ON When stopping, a error occurs or the PLC link is not performed: OFF
R906B		Unit no. 12 When normally communicating in the PLC link mode: ON When stopping, a error occurs or the PLC link is not performed: OFF
R906C		Unit no. 13 When normally communicating in the PLC link mode: ON

## 12.5 List of Special Relays

Relay no.	Name	Description
		When stopping, a error occurs or the PLC link is not performed: OFF
R906D		Unit no. 14 When normally communicating in the PLC link mode: ON When stopping, a error occurs or the PLC link is not performed: OFF
R906E		Unit no. 15 When normally communicating in the PLC link mode: ON When stopping, a error occurs or the PLC link is not performed: OFF
R906F		Unit no. 16 When normally communicating in the PLC link mode: ON When stopping, a error occurs or the PLC link is not performed: OFF

### WR907 (Specified in word unit)

Relay no.	Name	Description
R9070	MEWNET-W0 Operation mode relay for PLC link 0	Unit no. 1 Turns on when the unit no. 1 is in RUN mode. Turns off the unit is in PROG. mode.
R9071		Unit no. 2 Turns on when the unit no. 2 is in RUN mode. Turns off the unit is in PROG. mode.
R9072		Unit no. 3 Turns on when the unit no. 3 is in RUN mode. Turns off the unit is in PROG. mode.
R9073		Unit no. 4 Turns on when the unit no. 4 is in RUN mode. Turns off the unit is in PROG. mode.
R9074		Unit no. 5 Turns on when the unit no. 5 is in RUN mode. Turns off the unit is in PROG. mode.
R9075		Unit no. 6 Turns on when the unit no. 6 is in RUN mode. Turns off the unit is in PROG. mode.
R9076		Unit no. 7 Turns on when the unit no. 7 is in RUN mode. Turns off the unit is in PROG. mode.
R9077		Unit no. 8 Turns on when the unit no. 8 is in RUN mode. Turns off the unit is in PROG. mode.
R9078		Unit no. 9 Turns on when the unit no. 9 is in RUN mode. Turns off the unit is in PROG. mode.
R9079		Unit no. 10 Turns on when the unit no. 10 is in RUN mode. Turns off the unit is in PROG. mode.
R907A		Unit no. 11 Turns on when the unit no. 11 is in RUN mode. Turns off the unit is in PROG. mode.
R907B		Unit no. 12 Turns on when the unit no. 12 is in RUN mode. Turns off the unit is in PROG. mode.
R907C		Unit no. 13 Turns on when the unit no. 13 is in RUN mode. Turns off the unit is in PROG. mode.



## 12.5 List of Special Relays

Relay no.	Name	Description
R907D		Unit no. 14 Turns on when the unit no. 14 is in RUN mode. Turns off the unit is in PROG. mode.
R907E		Unit no. 15 Turns on when the unit no. 15 is in RUN mode. Turns off the unit is in PROG. mode.
R907F		Unit no. 16 Turns on when the unit no. 16 is in RUN mode. Turns off the unit is in PROG. mode.

### WR908 (Specified in word unit)

Relay no.	Name	Description
R9080	MEWNET-W0 Transmission assurance relay for PLC link 1	Unit no. 1 When normally communicating in the PLC link mode: ON When stopping, a error occurs or the PLC link is not performed: OFF
R9081		Unit no. 2 When normally communicating in the PLC link mode: ON When stopping, a error occurs or the PLC link is not performed: OFF
R9082		Unit no. 3 When normally communicating in the PLC link mode: ON When stopping, a error occurs or the PLC link is not performed: OFF
R9083		Unit no. 4 When normally communicating in the PLC link mode: ON When stopping, a error occurs or the PLC link is not performed: OFF
R9084		Unit no. 5 When normally communicating in the PLC link mode: ON When stopping, a error occurs or the PLC link is not performed: OFF
R9085		Unit no. 6 When normally communicating in the PLC link mode: ON When stopping, a error occurs or the PLC link is not performed: OFF
R9086		Unit no. 7 When normally communicating in the PLC link mode: ON When stopping, a error occurs or the PLC link is not performed: OFF
R9087		Unit no. 8 When normally communicating in the PLC link mode: ON When stopping, a error occurs or the PLC link is not performed: OFF
R9088		Unit no. 9 When normally communicating in the PLC link mode: ON When stopping, a error occurs or the PLC link is not performed: OFF

## 12.5 List of Special Relays

Relay no.	Name	Description
R9089		Unit no. 10 When normally communicating in the PLC link mode: ON When stopping, a error occurs or the PLC link is not performed: OFF
R908A		Unit no. 11 When normally communicating in the PLC link mode: ON When stopping, a error occurs or the PLC link is not performed: OFF
R908B		Unit no. 12 When normally communicating in the PLC link mode: ON When stopping, a error occurs or the PLC link is not performed: OFF
R908C		Unit no. 13 When normally communicating in the PLC link mode: ON When stopping, a error occurs or the PLC link is not performed: OFF
R908D		Unit no. 14 When normally communicating in the PLC link mode: ON When stopping, a error occurs or the PLC link is not performed: OFF
R908E		Unit no. 15 When normally communicating in the PLC link mode: ON When stopping, a error occurs or the PLC link is not performed: OFF
R908F		Unit no. 16 When normally communicating in the PLC link mode: ON When stopping, a error occurs or the PLC link is not performed: OFF

### WR909 (Specified in word unit)

Relay no.	Name	Description
R9090	MEWNET-W0 Operation mode relay for PLC link 1	Unit no. 1 Turns on when the unit no. 1 is in RUN mode. Turns off the unit is in PROG. mode.
R9091		Unit no. 2 Turns on when the unit no. 2 is in RUN mode. Turns off the unit is in PROG. mode.
R9092		Unit no. 3 Turns on when the unit no. 3 is in RUN mode. Turns off the unit is in PROG. mode.
R9093		Unit no. 4 Turns on when the unit no. 4 is in RUN mode. Turns off the unit is in PROG. mode.
R9094		Unit no. 5 Turns on when the unit no. 5 is in RUN mode. Turns off the unit is in PROG. mode.
R9095		Unit no. 6 Turns on when the unit no. 6 is in RUN mode. Turns off the unit is in PROG. mode.
R9096		Unit no. 7 Turns on when the unit no. 7 is in RUN mode. Turns off the unit is in PROG. mode.

## 12.5 List of Special Relays

Relay no.	Name	Description
R9097		Unit no. 8 Turns on when the unit no. 8 is in RUN mode. Turns off the unit is in PROG. mode.
R9098		Unit no. 9 Turns on when the unit no. 9 is in RUN mode. Turns off the unit is in PROG. mode.
R9099		Unit no. 10 Turns on when the unit no. 10 is in RUN mode. Turns off the unit is in PROG. mode.
R909A		Unit no. 11 Turns on when the unit no. 11 is in RUN mode. Turns off the unit is in PROG. mode.
R909B		Unit no. 12 Turns on when the unit no. 12 is in RUN mode. Turns off the unit is in PROG. mode.
R909C		Unit no. 13 Turns on when the unit no. 13 is in RUN mode. Turns off the unit is in PROG. mode.
R909D		Unit no. 14 Turns on when the unit no. 14 is in RUN mode. Turns off the unit is in PROG. mode.
R909E		Unit no. 15 Turns on when the unit no. 15 is in RUN mode. Turns off the unit is in PROG. mode.
R909F	Unit no. 16 Turns on when the unit no. 16 is in RUN mode. Turns off the unit is in PROG. mode.	

### WR910 to WR912 (Specified in word unit)

Relay no.	Name	Description
R9100 to R9107	Reserved for system	-
R9108	Hold area data error flag	Turns on when a battery runs out and data cannot be held, and turns off when the power supply turns off.
R9109	Memory configuration mismatch detection flag	[C32E only] Turns ON when a memory configuration inconsistency is detected. Turns OFF in normal conditions.
R910A to R910F	Reserved for system	-
R9110	High-speed counter control flag	HSC-CH0
R9111		HSC-CH1
R9112		HSC-CH2
R9113		HSC-CH3
R9114 to R911B	Reserved for system	-
R911C	Pulse output instruction active flag	PLS-CH0
R911D		PLS-CH1
R911E		PLS-CH2
R911F		PLS-CH3
R9120	Reserved for system	-

## 12.5 List of Special Relays

Relay no.	Name	Description
to R912F		

### WR913 (Specified in word unit)

Relay no.	Name	Description
R9130 (R900E)	COM0 port communication error flag	Turns on if a transmission error occurs when performing data communication. Turns off when a transmission request is made by the F159 (MTRN) instruction.
R9131 (R9040)	COM0 port communication mode flag	Turns on when using the general-purpose communication function. Turns off when using a function other than the general-purpose communication function.
R9132 (R903E)	COM0 port transmission done flag during general-purpose communication	Turns on when the end code is received in the general-purpose communication. Turns off when the transmission is requested in the general-purpose communication.
R9133 (R903F)	COM0 port transmission done flag during general-purpose communication	Turns on when the transmission ends in the general-purpose communication. Turns off when the transmission is requested in the general-purpose communication.
R9134	COM0 port SEND/RECV instruction execution flag	Indicates whether the F145 (SEND) or F146 (RECV) instruction can be executed or not for the COM0 port. OFF: Not executable (Instruction is being executed) ON: Executable
R9135	COM0 port SEND/RECV instruction execution end flag	Indicates the execution state of the F145 (SEND) or F146 (RECV) instruction for the COM0 port. OFF: Normal end ON: Abnormal end (Communication error occurs) The error code is stored in DT90123.
R9136	COM0 port PLC link flag	Turns on when using the PLC link function.
R9137	Reserved for system	-
R9138 (R9037)	COM1 port communication error flag	Turns on if a transmission error occurs when performing data communication. Turns off when a transmission request is made by the F159 (MTRN) instruction.
R9139 (R9032)	COM1 port communication mode flag	Turns on when using the general-purpose communication function. Turns off when using a function other than the general-purpose communication function.
R913A (R9038)	COM1 port reception done flag during general-purpose communication	Turns on when the end code is received in the general-purpose communication. Turns off when the transmission is requested in the general-purpose communication.
R913B (R9039)	COM1 port transmission done flag during general-purpose communication	Turns on when the transmission ends in the general-purpose communication. Turns off when the transmission is requested in the general-purpose communication.

Relay no.	Name	Description
R913C (R9044)	COM1 port SEND/RECV instruction execution flag	Indicates whether the F145 (SEND) or F146 (RECV) instruction can be executed or not for the COM1 port. OFF: Not executable (Instruction is being executed) ON: Executable
R913D (R9045)	COM1 port SEND/RECV instruction execution end flag	Indicates the execution state of the F145 (SEND) or F146 (RECV) instruction for the COM1 port. OFF: Normal end ON: Abnormal end (Communication error occurs) The error code is stored in DT90124.
R913E (R9041)	COM1 port PLC link flag	Turns on when using the PLC link function.
R913F	Reserved for system	-

(Note 1) R9130 to R913F will change even during one scanning cycle. In addition, the same functions are allocated to the special internal relays in parentheses to retain compatibility with the conventional model FPsigma Control Unit.

#### WR914 (Specified in word unit)

Relay no.	Name	Description
R9140 (R9047)	COM2 port communication error flag	Turns on if a transmission error occurs when performing data communication. Turns off when a transmission request is made by the F159 (MTRN) instruction.
R9141 (R9042)	COM2 port communication mode flag	Turns on when using the general-purpose communication function. Turns off when using a function other than the general-purpose communication function.
R9142 (R9048)	COM2 port reception done flag during general-purpose communication	Turns on when the end code is received in the general-purpose communication. Turns off when the transmission is requested in the general-purpose communication.
R9143 (R9049)	COM2 port transmission done flag during general-purpose communication	Turns on when the transmission ends in the general-purpose communication. Turns off when the transmission is requested in the general-purpose communication.
R9144 (R904A)	COM2 port SEND/RECV instruction execution flag	Indicates whether the F145 (SEND) or F146 (RECV) instruction can be executed or not for the COM2 port. OFF: Not executable (Instruction is being executed) ON: Executable
R9145 (R904B)	COM2 port SEND/RECV instruction execution end flag	Indicates the execution state of the F145 (SEND) or F146 (RECV) instruction for the COM2 port. OFF: Normal end ON: Abnormal end (Communication error occurs) The error code is stored in DT90125.
R9146 to R914F	Reserved for system	-

## 12.5 List of Special Relays

(Note 1) R9140 to R914F will change even during one scanning cycle. In addition, the same functions are allocated to the special internal relays in parentheses to retain compatibility with the conventional model FPsigma Control Unit.

### WR915 (Specified in word unit)

Relay no.	Name	Description
R9150 to R915F	Reserved for system	-

### WR916 (Specified in word unit)

Relay no.	Name	Description
R9160 to R9161	Reserved for system	-
R9162	RTC error	Turns on if an error is detected in calendar timer data when the unit is powered on. Also, it turns on when inappropriate date and time are written during the operation.
R9163 to R9165	Reserved for system	-
R9166	SNTP time updating failure	Turns on if acquisition of time data has failed during time synch via LAN port. Turns off in normal conditions.
R9167	SNTP time update completed	Turns off when time is being updated with SNTP, and turns on when the update is completed.
R9168 to R916E	Reserved for system	-
R916F	SD card project being copied	Turns ON when project is being copied.

### WR917 (Specified in word unit)

Relay no.	Name	Description
R9170	SD slot cover status flag	ON: Cover open OFF: Cover closed
R9171	SD memory card attachment flag	ON: With an SD memory card OFF: Without an SD memory card
R9172	SD memory card recognition completed flag	ON: Completed recognition of an SD memory card OFF: Other than the above
R9173	SD memory card recognition result flag	ON: Error OFF: Normal
R9174	SD memory card write protection flag	ON: Protected OFF: Not protected
R9175	SD memory card type	ON : SD OFF: SDHC
R9176	SD memory card file system	ON: FAT16 OFF: FAT32
R9177	During FTP server log-in	ON: Logged in OFF: Not logged in
R9178	Logging/trace execution (Note 1)	On: Being executed

Relay no.	Name	Description
		OFF: Stops
R9179	Logging/trace buffer storage / File being written (Note 2)	ON: Buffer storage / File being written OFF: Other than the above
R917A	Running SD card access instruction	ON: Instruction execution started OFF: Instruction execution completed
R917B	Completed SD card access instruction execution	ON: Instruction execution completed OFF: Instruction execution started
R917C	Result of SD card access instruction execution	Reports the result when the instruction is completed. ON: Abnormal end OFF: Normal end
R917D to R917E	Reserved for system	-
R917F	Powered off while accessing SD memory card	Turns on if the CPU unit is powered off while accessing an SD memory card.

(Note 1) Turns on when the logging/trace is being executed. Turns off when all stop.

(Note 2) Turns on when buffer storage is performed or file is being written. Turns off when all are other than those operations.

### WR918 (Specified in word unit)

Relay no.	Name	Description
R9180	LOG0 Logging/trace execution	Turns on when the logging trace is performed. Other relays in LOGn turn off during the startup operation. Storing data in the buffer memory is executed while this relay turns on.
R9181	LOG0 SD card logging buffer storage/File being written	Turns on when writing files to a SD card becomes enabled after the logging trace execution relay turned on (buffer logging was enabled).
R9182	LOG0 Logging/trace completed	Turns on after the completion of file writing when stopping the logging trace is requested or it is automatically stopped.
R9183	LOG0 Logging over-speed relay	Turns on when the buffer logging speed exceeds the writing speed to a SD memory card in logging operations. Turns on when the number of data previously stored and the number of data stored this time increase. Turns on at the time of buffer storage, and turns off at the time of writing data to an SD memory card or the end of scan.
R9184	LOG0 Buffer overflow	Turns on when the buffer memory has been exhausted. At that time, new data cannot be stored. The value of the buffer overflow counter DT90620 is incremented by one. In that case, writing to SD card does not stop. Turns off at the end of scan when buffer vacancy occurs while writing to an SD memory card is performed. The buffer overflow counter DT90620 is cleared to 0. After buffer vacancy occurred, data logging is executed at the timing of logging to the buffer.
R9185	LOG0 Logging/trace error	Turns on when an error is detected during the logging trace and stops the logging trace.

## 12.5 List of Special Relays

Relay no.	Name	Description
R9186	LOG0 No SD card free space	Turns on when one of the following conditions is met during the logging/trace operation and stops the logging/trace operation. <ul style="list-style-type: none"> <li>There is no free capacity in an SD memory card.</li> <li>An error in accessing an SD memory card occurs.</li> </ul>
R9187	LOG0 Device and trigger setting error	Turns on when an error is detected in setting values during the startup operation. The error relay R9185 also turns on. At that time, the execution relay R9180 does not turn on as the logging trace function cannot be started.
R9188	LOG0 Trace stop trigger monitor	Monitors a registered trace stop trigger when executing tracing. Turns on when conditions are met.
R9189	LOG0 Trace data acquisition completed	Turns on after logging data for a specified number of times after detecting the tracing stop trigger during the execution of trace.
R918A to R918F	Reserved for system	-

### WR919 (Specified in word unit)

Relay no.	Name	Description
R9190	LOG1 Logging/trace execution	For the details of each control relay, refer to the description for LOG0.
R9191	LOG1 SD card logging buffer storage/File being written	
R9192	LOG1 Logging/trace completed	
R9193	LOG1 Logging over-speed relay	
R9194	LOG1 Buffer overflow	
R9195	LOG1 Logging/trace error	
R9196	LOG1 No SD card free space	
R9197	LOG1 Device and trigger setting error	
R9198	LOG1 Trace stop trigger monitor	
R9199	LOG1 Trace data acquisition completed	
R919A to R919F	Reserved for system	-

### WR920 (Specified in word unit)

Relay no.	Name	Description
R9200	LOG2 Logging/trace execution	For the details of each control relay, refer to the description for LOG0.
R9201	LOG2 SD card logging buffer storage/File being written	
R9202	LOG2 Logging/trace completed	
R9203	LOG2 Logging over-speed relay	
R9204	LOG2 Buffer overflow	
R9205	LOG2 Logging/trace error	



Relay no.	Name	Description
R9206	LOG2 No SD card free space	
R9207	LOG2 Device and trigger setting error	
R9208	LOG2 Trace stop trigger monitor	
R9209	LOG2 Trace data acquisition completed	
R920A to R920F	Reserved for system	-

**WR921 (Specified in word unit)**

Relay no.	Name	Description
R9210	LOG3 Logging/trace execution	For the details of each control relay, refer to the description for LOG0.
R9211	LOG2 SD card logging buffer storage/File being written	
R9212	LOG3 Logging/trace completed	
R9213	LOG3 Logging over-speed relay	
R9214	LOG3 Buffer overflow	
R9215	LOG3 Logging/trace error	
R9216	LOG3 No SD card free space	
R9217	LOG3 Device and trigger setting error	
R9218	LOG3 Trace stop trigger monitor	
R9219	LOG3 Trace data acquisition completed	
R921A to R921F	Reserved for system	-

**WR922 to WR933 (Specified in word unit)**

Relay no.	Name	Description
R9220 to R933F	Reserved for system	-

**WR934 (Specified in word unit)**

Relay no.	Name	Description
R9340	Ethernet cable disconnection detection	ON: Disconnected OFF: Connected
R9341	Ethernet initialization active	ON: Being initialized OFF: Initialization completed
R9342	IP address determination	ON: Determined OFF: Undetermined
R9343	Reserved for system	-
R9344	FTP server is ready	ON: Preparation completed

## 12.5 List of Special Relays

Relay no.	Name	Description
		OFF: Unusable
R9345	FTP client is ready	ON: Preparation completed OFF: Unusable
R9346 to R934F	Reserved for system	-

### WR935 (Specified in word unit)

Relay no.	Name	Description
R9350	EtherNet/IP preparation done flag	ON: ESDK online OFF: ESDK offline
R9351	EtherNet/IP all nodes normal communication active relay	ON: Normal OFF: Error
R9352	EtherNet/IP all nodes stop relay	ON: Stop OFF: Not stop
R9353	EtherNet/IP abnormal node exists	ON: Exists OFF: Not exist
R9354	EtherNet/IP start/stop control enabled	ON: Controllable OFF: Not controllable
R9355 to R935F	Reserved for system	-

### WR936 (Specified in word unit)

Relay no.	Name	Description
R9360	User connection 1	Communication error flag Completion code: DT90840 ON: Transmission error in data communication occurs OFF: F159 (MTRN) instruction is executed
R9361		Reception done flag in general-purpose communication ON: Terminator is received in general-purpose communication OFF: Transmission is requested in general-purpose communication
R9362		Transmission done flag in general-purpose communication ON: On completion of transmission in general-purpose communication OFF: Transmission is requested in general-purpose communication
R9363		SEND/RECV instruction enable flag ON: Enabled OFF: Disabled
R9364		SEND/RECV instruction done flag Completion code: DT90840 ON: Abnormal end (Communication error occurs) OFF: Normal end
R9365		Connection status flag ON: Connected OFF: Not connected
R9366 to R9367	Reserved for system	-

Relay no.	Name	Description
R9368	User connection 2	Communication error flag Completion code: DT90841 ON: Transmission error in data communication occurs OFF: F159 (MTRN) instruction is executed
R9369		Reception done flag in general-purpose communication ON: Terminator is received in general-purpose communication OFF: Transmission is requested in general-purpose communication
R936A		Transmission done flag in general-purpose communication ON: On completion of transmission in general-purpose communication OFF: Transmission is requested in general-purpose communication
R936B		SEND/RECV instruction enable flag ON: Enabled OFF: Disabled
R936C		SEND/RECV instruction done flag Completion code: DT90841 ON: Abnormal end (Communication error occurs) OFF: Normal end
R936D		Connection status flag ON: Connected OFF: Not connected
R936E to R936F	Reserved for system	-

**WR937 (Specified in word unit)**

Relay no.	Name	Description
R9370	User connection 3	Communication error flag Completion code: DT90842 ON: Transmission error in data communication occurs OFF: F159 (MTRN) instruction is executed
R9371		Reception done flag in general-purpose communication ON: Terminator is received in general-purpose communication OFF: Transmission is requested in general-purpose communication
R9372		Transmission done flag in general-purpose communication ON: On completion of transmission in general-purpose communication OFF: Transmission is requested in general-purpose communication
R9373		SEND/RECV instruction enable flag ON: Enabled OFF: Disabled
R9374		SEND/RECV instruction done flag Completion code: DT90842 ON: Abnormal end (Communication error occurs) OFF: Normal end
R9375		Connection status flag ON: Connected OFF: Not connected
R9376 to R9377	Reserved for system	-

## 12.5 List of Special Relays

Relay no.	Name	Description
R9378	User connection 4	Communication error flag Completion code: DT90843 ON: Transmission error in data communication occurs OFF: F159 (MTRN) instruction is executed
R9379		Reception done flag in general-purpose communication ON: Terminator is received in general-purpose communication OFF: Transmission is requested in general-purpose communication
R937A		Transmission done flag in general-purpose communication ON: On completion of transmission in general-purpose communication OFF: Transmission is requested in general-purpose communication
R937B		SEND/RECV instruction enable flag ON: Enabled OFF: Disabled
R937C		SEND/RECV instruction done flag Completion code: DT90843 ON: Abnormal end (Communication error occurs) OFF: Normal end
R937D		Connection status flag ON: Connected OFF: Not connected
R937E to R937F	Reserved for system	-

### WR938 (Specified in word unit)

Relay no.	Name	Description
R9380	User connection 5	Communication error flag Completion code: DT90844 ON: Transmission error in data communication occurs OFF: F159 (MTRN) instruction is executed
R9381		Reception done flag in general-purpose communication ON: Terminator is received in general-purpose communication OFF: Transmission is requested in general-purpose communication
R9382		Transmission done flag in general-purpose communication ON: On completion of transmission in general-purpose communication OFF: Transmission is requested in general-purpose communication
R9383		SEND/RECV instruction enable flag ON: Enabled OFF: Disabled
R9384		SEND/RECV instruction done flag Completion code: DT90844 ON: Abnormal end (Communication error occurs) OFF: Normal end
R9385		Connection status flag ON: Connected OFF: Not connected
R9386 to R9387	Reserved for system	-

Relay no.	Name	Description
R9388	User connection 6	Communication error flag Completion code: DT90845 ON: Transmission error in data communication occurs OFF: F159 (MTRN) instruction is executed
R9389		Reception done flag in general-purpose communication ON: Terminator is received in general-purpose communication OFF: Transmission is requested in general-purpose communication
R938A		Transmission done flag in general-purpose communication ON: On completion of transmission in general-purpose communication OFF: Transmission is requested in general-purpose communication
R938B		SEND/RECV instruction enable flag ON: Enabled OFF: Disabled
R938C		SEND/RECV instruction done flag Completion code: DT90845 ON: Abnormal end (Communication error occurs) OFF: Normal end
R938D		Connection status flag ON: Connected OFF: Not connected
R938E to R938F	Reserved for system	-

**WR939 (Specified in word unit)**

Relay no.	Name	Description
R9390	User connection 7	Communication error flag Completion code: DT90846 ON: Transmission error in data communication occurs OFF: F159 (MTRN) instruction is executed
R9391		Reception done flag in general-purpose communication ON: Terminator is received in general-purpose communication OFF: Transmission is requested in general-purpose communication
R9392		Transmission done flag in general-purpose communication ON: On completion of transmission in general-purpose communication OFF: Transmission is requested in general-purpose communication
R9393		SEND/RECV instruction enable flag ON: Enabled OFF: Disabled
R9394		SEND/RECV instruction done flag Completion code: DT90846 ON: Abnormal end (Communication error occurs) OFF: Normal end
R9395		Connection status flag ON: Connected OFF: Not connected
R9396 to R9397	Reserved for system	-

## 12.5 List of Special Relays

Relay no.	Name	Description
R9398	User connection 8	Communication error flag Completion code: DT90847 ON: Transmission error in data communication occurs OFF: F159 (MTRN) instruction is executed
R9399		Reception done flag in general-purpose communication ON: Terminator is received in general-purpose communication OFF: Transmission is requested in general-purpose communication
R939A		Transmission done flag in general-purpose communication ON: On completion of transmission in general-purpose communication OFF: Transmission is requested in general-purpose communication
R939B		SEND/RECV instruction enable flag ON: Enabled OFF: Disabled
R939C		SEND/RECV instruction done flag Completion code: DT90847 ON: Abnormal end (Communication error occurs) OFF: Normal end
R939D		Connection status flag ON: Connected OFF: Not connected
R939E to R939F	Reserved for system	-

### WR940 (Specified in word unit)

Relay no.	Name	Description
R9400	User connection 9	Communication error flag Completion code: DT90848 ON: Transmission error in data communication occurs OFF: F159 (MTRN) instruction is executed
R9401		Reception done flag in general-purpose communication ON: Terminator is received in general-purpose communication OFF: Transmission is requested in general-purpose communication
R9402		Transmission done flag in general-purpose communication ON: On completion of transmission in general-purpose communication OFF: Transmission is requested in general-purpose communication
R9403		SEND/RECV instruction enable flag ON: Enabled OFF: Disabled
R9404		SEND/RECV instruction done flag Completion code: DT90848 ON: Abnormal end (Communication error occurs) OFF: Normal end
R9405		Connection status flag ON: Connected OFF: Not connected
R9406 to R940F	Reserved for system	-

## 12.6 List of Special Data Registers

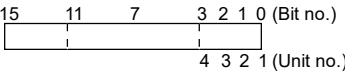
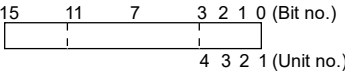
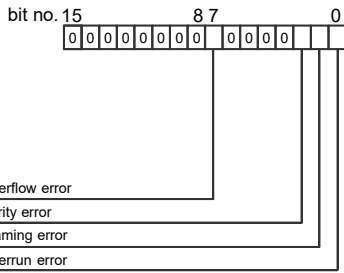
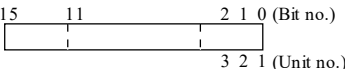
Register no.	Name	Description	R	W
DT90000	Self-diagnosis error code	When a self-diagnostic error occurs, the error code is stored.	•	
DT90001	Reserved for system	-		
DT90002	FP0H/FPsigma Expansion (Left expansion) Position of abnormal I/O unit	When an error occurs in the I/O unit of FP0H/FPsigma Expansion Unit (left expansion) occurs, the corresponding bit turns on.   ON(1): Abnormal OFF(0): Normal	•	
DT90003 to DT90005	Reserved for system	-		
DT90006	FP0H/FPsigma Expansion (Left expansion) Position of abnormal intelligent unit	When an error occurs in the intelligent unit of FP0H/FPsigma Expansion Unit (left expansion) occurs, the corresponding bit turns on.   ON(1): Abnormal OFF(0): Normal	•	
DT90007	system register error no.	When there is an inconsistency in the setting of a system register, the corresponding system register no. is stored.	•	
DT90008	Reserved for system	-		
DT90009	Communication error flag	The error content when using the COM2 port is stored. ON (1): Error, OFF (0): Normal   COM2 Overflow error COM2 Parity error COM2 Framing error COM2 Overrun error	•	
DT90010	FP0/FP0R Expansion (Right expansion) Position of I/O verification mismatched unit	When the installation state of FP0/FP0R Expansion Unit changes from the state when the power turns on, the bit corresponding to the unit number turns on (1). Monitor with BIN display.   ON(1): Abnormal OFF(0): Normal	•	
DT90011	FP0H/FPsigma Expansion (Left expansion) Position of I/O verification mismatched unit	When the installation state of FP0H/FPsigma Expansion Unit (left expansion) changes from the state when the power turns on, the bit corresponding to the unit number turns on (1). Monitor with BIN display.	•	

## 12.6 List of Special Data Registers

Register no.	Name	Description	R	W
		<p>ON(1): Abnormal OFF(0): Normal</p>		
DT90012	SD card project copy control area	<p>When 1 is written to this register, the SD card project copy will be started.</p> <p>2 will be set during the execution.</p> <p>3 will be set when the operation is completed successfully.</p> <p>When an error occurs, an error code (65 or 70 to 75) will be set.</p> <p>Note: Writing is available only in PROG. mode.</p>	•	• (Note 1)
DT90013	Reserved for system	-		
DT90014	Operation auxiliary register for data shift instruction	<p>As a result of the execution of data shift instruction F105 (BSR) or F106 (BSL), the overflowed 1-digit data is stored in bit 0 to bit 3.</p> <p>Reading and writing the value is available by the F0 (MV) instruction.</p>	•	•
DT90015	Operation auxiliary register for division instruction	When executing the 16-bit division instruction F32(%) or F52(B%), the remainder of 16 bits is stored in DT90015.	•	•
DT90016		When executing the 32-bit division instruction F33(D%) or F53(DB%), the remainder of 32 bits is stored in DT90015 to DT90016. Reading and writing the value is available by the F1 (DMV) instruction.		
DT90017	Address with operation error (Hold)	The address where the first operation error occurred after starting the operation is stored. Monitor using decimal display.	•	
DT90018	Address with operation error (Latest)	The address where the operation error occurred is stored. It will be updated every time an error occurs. Monitor using decimal display.	•	
DT90019	RING counter (2.5 ms) <sup>(Note 2)</sup>	<p>The stored value is incremented by one every 2.5 ms. (H0 to HFFFF)</p> <p>Difference between the values of 2 points (absolute value) x 2.5 ms = Elapsed time between the 2 points</p>	•	
DT90020	RING counter (10μs) (Note 2) (Note 3)	<p>The stored value is incremented by one every 10.00 μs. (H0 to HFFFF)</p> <p>Difference between the values of 2 points (absolute value) x 10.00 s = Elapsed time between the 2 points</p> <p>Note) The accurate figure is 10.00 s.</p>	•	
DT90021	Reserved for system	-		
DT90022	Scan time (Current value) <sup>(Note 4)</sup>	<p>The current value of scan time is stored.</p> <p>[Stored value (decimal)] x 0.1 ms</p> <p>Example) For K50, it is within 5 ms.</p>	•	
DT90023	Scan time (Minimum value) (Note 4)	<p>The minimum value of scan time is stored.</p> <p>[Stored value (decimal)] x 0.1 ms</p> <p>Example) For K50, it is within 5 ms.</p>	•	
DT90024	Scan time (Maximum value) (Note 4)	<p>The maximum value of scan time is stored.</p> <p>[Stored value (decimal)] x 0.1 ms</p> <p>Example) For K125, it is within 12.5 ms.</p>	•	



## 12.6 List of Special Data Registers

Register no.	Name	Description	R	W
DT90025	Interrupt enable (mask) status (INT0 to 7)	<p>The content set by the ICTL instruction is stored. Monitor with BIN display.</p> <p>15 13 11 7 3 0 (Bit no.)</p> <p>0: Interrupt disabled 1: Interrupt enabled</p> <p>INT0 to INT7: Interrupt input X0 to X7</p>	•	
DT90026	Reserved for system	-		
DT90027	Periodical interrupt interval (INT24)	<p>The content set by the ICTL instruction is stored.</p> <p>K0: Periodical interrupt is not used K1 to K3000: 0.1 ms to 0.35 s or 0.5 ms to 1.5 s or 10 ms to 30 s</p>	•	
DT90028	Interval of sampling trace	<p>K0: Sampling by the SMPL instruction K1 to K3000 (×10ms): 10 ms to 30 s</p>	•	
DT90029	Reserved for system	-		
DT90030	Character storage by F149 MSG instruction	The content (characters) set by the message display instruction (F149) is stored.	•	
DT90031				
DT90032				
DT90033				
DT90034				
DT90035				
DT90036	Position where the status error of left expansion unit occurred	When the status of the left expansion unit is abnormal, the number indicating the position is stored.	•	
DT90037	Operation auxiliary register for SRC instruction	When executing the F96 (SRC) instruction, the number that matches the search data is stored.	•	
DT90038	Operation auxiliary register for SRC instruction	When executing the F96 (SRC) instruction, the relative position that matches is stored.	•	
DT90039	Reserved for system	-		
DT90040	Potentiometer input V0 <sup>(Note 5)</sup>	<p>The value of potentiometer input (K0 to K4000) is stored.</p> <p>It can be applied to the analog timer by reading it to the data register using a user program.</p>	•	
DT90041	Potentiometer input V1 <sup>(Note 5)</sup>	<p>The value of potentiometer input (K0 to K4000) is stored.</p> <p>It can be applied to the analog timer by reading it to the data register using a user program.</p>	•	
DT90042 to DT90043	Reserved for system	-		

(Note 1) Not possible to write to DT90012 using an instruction. Use the tool software to write to DT90012.

(Note 2) It is updated once at the beginning of every scan.

(Note 3) DT90020 is also updated when executing the F0 (MV), DT90020 and D instructions, therefore, it can be used for measuring a block time.

## 12.6 List of Special Data Registers

(Note 4) The scan time display shows the operation cycle time only in RUN mode. In PROG. mode, the scan time of operation is not displayed. The maximum and minimum values are cleared when switching the mode between RUN and PROG.

(Note 5) It is available only for C32T/C32P. For the FPsigma mode, the value of potentiometer is K0 to 1000.

Register no.	Name		Description	R	W
DT90044	Elapsed value area	Low word	[FPsigma mode] The counting area of the pulse output CH0 (Y0, Y1) or the high-speed counter input CH0 (X0).	•	•
DT90045		High word			
DT90046	Target value area	Low word	[FPsigma mode] The target value is set when executing F166 HC1S, F167 HC1R, or pulse output instruction (F17x).	•	
DT90047		High word			
DT90048	Elapsed value area	Low word	[FPsigma mode] The counting area of the high-speed counter input CH1 (X1).	•	•
DT90049		High word			
DT90050	Target value area	Low word	[FPsigma mode] The target value is set when executing F166 HC1S or F167 HC1R instruction.	•	
DT90051		High word			
DT90052	High-speed counter control flag		<p>When using the high-speed counter function, various controls such as resetting the high-speed counter, disabling the count and clearing the execution of an instruction can be performed by writing values with the MV instruction (F0).</p> <p>bit no. 15 8 7 0</p> <p>Channel specification H0 to H3: CH0 to CH3</p> <p>H00: Fixed (Note 2)</p> <p>High-speed counter instruction 0: Continue, 1: Clear</p> <p>External reset input 0: Valid, 1: Invalid</p> <p>Count 0: Enable 1: Disable</p> <p>Software reset 0: Disable, 1: Enable</p>	•	•
	Pulse output control flag		<p>When using the pulse output function by the F17x instruction, various controls such as near home input, stopping the pulse output and canceling an instruction can be performed by writing values using the MV instruction (F0).</p> <p>bit no. 15 8 7 4 3 1 0</p> <p>Channel specification H0 to H3: CH0 to CH3</p> <p>H1: Fixed (Note 2)</p> <p>Near home 0: Invalid 1: Valid</p> <p>Pulse output 0: Continue 1: Stop</p> <p>Count 0: Enable 1: Disable</p> <p>Software reset 0: Disable 1: Enable</p>		

## 12.6 List of Special Data Registers

(Note 1) When selecting the positioning function in the table setting mode, the control using the pulse output control flag by DT90052 cannot be performed.

(Note 2) In the FPsigma mode, they are empty bits.

Register no.	Name	Description	R	W												
DT90053	Real-time clock monitoring (hour and minute)	<p>The hour and minute data of the real-time clock is stored.</p> <p>You can only read, cannot write.</p> <div style="text-align: center;"> </div>	•													
DT90054	Real-time clock (minute and second)	<p>The year, month, day, hour, minute, second and day-of-the-week data of the real-time clock is stored. The built-in real-time clock is applicable until 2099 and supports leap years.</p> <p>The real-time clock can be set (time synch) by writing desired values using the programming tool or a program based on the transfer instruction (F0).</p> <div style="text-align: center;"> </div> <table border="1" style="margin: 10px auto;"> <tr> <td>DT90054</td> <td>Minute data (H00 to H59)</td> <td>Second data (H00 to H59)</td> </tr> <tr> <td>DT90055</td> <td>Day data (H01 to H31)</td> <td>Hour data (H00 to H23)</td> </tr> <tr> <td>DT90056</td> <td>Year data (H00 to H99)</td> <td>Month data (H01 to H12)</td> </tr> <tr> <td>DT90057</td> <td>—</td> <td>Day of week data (H00 to H06)</td> </tr> </table> <p>The day of the week is not set automatically. Allocate an arbitrary value in the range of H0 to H6 (0: Sunday, 1: Monday, 2: Tuesday, 3: Wednesday, 4: Thursday, 5: Friday, 6: Saturday).</p>	DT90054	Minute data (H00 to H59)	Second data (H00 to H59)	DT90055	Day data (H01 to H31)	Hour data (H00 to H23)	DT90056	Year data (H00 to H99)	Month data (H01 to H12)	DT90057	—	Day of week data (H00 to H06)	•	•
DT90054	Minute data (H00 to H59)		Second data (H00 to H59)													
DT90055	Day data (H01 to H31)		Hour data (H00 to H23)													
DT90056	Year data (H00 to H99)		Month data (H01 to H12)													
DT90057	—	Day of week data (H00 to H06)														
DT90055	Real-time clock (day and hour)															
DT90056	Real-time clock (year and month)															
DT90057	Real-time clock (day of week)															
DT90058	Realtime clock time setting and 30-second compensation register	<p>It is used to adjust the time of the built-in realtime clock.</p> <ul style="list-style-type: none"> <li>Adjust the time by a program           <p>By setting the MSB of DT90058 to 1, the time is adjusted to that written to DT90054 to DT90057 by the F0 instruction. After the execution of the time adjustment, DT90058 will be cleared to zero. (It cannot be executed using any other instructions than F0 instruction.)</p> <p>&lt;Example&gt; Turn X0 on to set the time to 12:00:00 on the 5th day.</p> <div style="text-align: center;"> </div> <p style="margin-left: 20px;">Set 0 minute 0 second Set 12th hour 5th day. Set the time.</p> </li> <li>Correct a difference within 30 seconds.           <p>By setting the LSB to 1, the time is moved up or down to be just 0 second.</p> <p>After the execution of the correction, DT90058 will be cleared to zero.</p> <p>&lt;Example&gt; Turn X0 on to correct the time to be 0 second.</p> </li> </ul>	•	•												

## 12.6 List of Special Data Registers

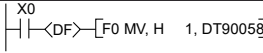
Register no.	Name	Description	R	W
		 <p>Correct to 0 second.</p> <p>When is 0 to 29 seconds when executed, it is moved down. When it is 30 to 59 seconds, it is moved up. In the above example, when it is 5 minutes 29 seconds, it will be 5 minutes 0 second. When it is 5 minutes 35 seconds, it will be 6 minutes 0 second.</p>		

(Note 1) When rewriting the values of DT90054 to DT90057 using the programming tool, it is not necessary to write the data to DT90058 because the time adjustment is performed when rewritten.

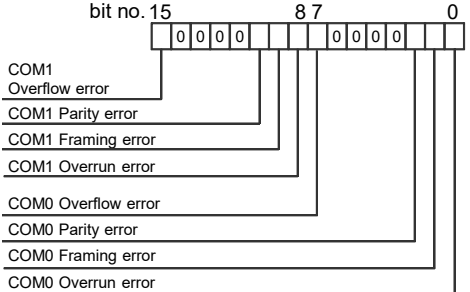
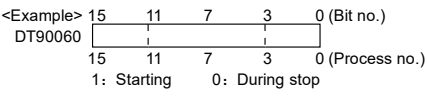
Register no.	Name	Description	R	W	
DT90059	Communication error code COM0 port/COM1 port	<p>When a communication error occurs, the error code is stored.</p> <p>ON (1): Error, OFF (0): Normal</p> 	•		
DT90060	Step ladder process (0 to 15)	<p>Indicates the starting status of the step ladder process. When the process starts, the bit corresponding to its process number turns on.</p> <p>Monitor with BIN display.</p> <p>&lt;Example&gt;  (Bit no.)</p> <p>15 11 7 3 0 (Process no.)</p> <p>1: Starting 0: During stop</p> <p>The data can be written using the programming tool.</p>			
DT90061	Step ladder process (16 to 31)				
DT90062	Step ladder process (32 to 47)				
DT90063	Step ladder process (48 to 63)				
DT90064	Step ladder process (64 to 79)				
DT90065	Step ladder process (80 to 95)				
DT90066	Step ladder process (96 to 111)			•	•
DT90067	Step ladder process (112 to 127)				
DT90068	Step ladder process (128 to 143)				
DT90069	Step ladder process (144 to 159)				
DT90070	Step ladder process (160 to 175)				
DT90071	Step ladder process (176 to 191)				

## 12.6 List of Special Data Registers

Register no.	Name	Description	R	W
DT90072	Step ladder process (192 to 207)			
DT90073	Step ladder process (208 to 223)			
DT90074	Step ladder process (224 to 239)			
DT90075	Step ladder process (240 to 255)			
DT90076	Step ladder process (256 to 271)			
DT90077	Step ladder process (272 to 287)			
DT90078	Step ladder process (288 to 303)			
DT90079	Step ladder process (304 to 319)			
DT90080	Step ladder process (320 to 335)			
DT90081	Step ladder process (336 to 351)			
DT90082	Step ladder process (352 to 367)			
DT90083	Step ladder process (368 to 383)			
DT90084	Step ladder process (384 to 399)			
DT90085	Step ladder process (400 to 415)			
DT90086	Step ladder process (416 to 431)	Indicates the starting status of the step ladder process. When the process starts, the bit corresponding to its process number turns on.		
DT90087	Step ladder process (432 to 447)	Monitor with BIN display.		
DT90088	Step ladder process (448 to 463)	<p>&lt;Example&gt; 15      11      7      3      0 (Bit no.)</p> <p>DT90100      ← 655 ← 651      ← 647 ← 643 ← 640(Process no.)</p> <p>1: Starting      0: During stop</p>		
DT90089	Step ladder process (464 to 479)	The data can be written using the programming tool.		
DT90090	Step ladder process (480 to 495)			
DT90091	Step ladder process (496 to 511)			
DT90092	Step ladder process (512 to 527)			
DT90093	Step ladder process (528 to 543)			
DT90094	Step ladder process (544 to 559)			

## 12.6 List of Special Data Registers

Register no.	Name	Description	R	W
DT90095	Step ladder process (560 to 575)			
DT90096	Step ladder process (576 to 591)			
DT90097	Step ladder process (592 to 607)			
DT90098	Step ladder process (608 to 623)			
DT90099	Step ladder process (624 to 639)			
DT90100	Step ladder process (640 to 655)			
DT90101	Step ladder process (656 to 671)			
DT90102	Step ladder process (672 to 687)			
DT90103	Step ladder process (688 to 703)			
DT90104	Step ladder process (704 to 719)			
DT90105	Step ladder process (720 to 735)			
DT90106	Step ladder process (736 to 751)			
DT90107	Step ladder process (752 to 767)			
DT90108	Step ladder process (768 to 783)			
DT90109	Step ladder process (784 to 799)			
DT90110	Step ladder process (800 to 815)	Indicates the starting status of the step ladder process. When the process starts, the bit corresponding to its process number turns on. Monitor with BIN display.		
DT90111	Step ladder process (816 to 831)	<p>&lt;Example&gt;</p> <p>DT90100</p> <p>1: Starting    0: During stop</p>		
DT90112	Step ladder process (832 to 847)	The data can be written using the programming tool.		
DT90113	Step ladder process (848 to 863)			
DT90114	Step ladder process (864 to 879)			
DT90115	Step ladder process (880 to 895)			
DT90116	Step ladder process (896 to 911)			
DT90117	Step ladder process (912 to 927)			

## 12.6 List of Special Data Registers

Register no.	Name	Description	R	W
DT90118	Step ladder process (928 to 943)			
DT90119	Step ladder process (944 to 959)			
DT90120	Step ladder process (960 to 975)			
DT90121	Step ladder process (976 to 991)			
DT90122	Step ladder process (992 to 999) (High byte is not used.)			
DT90123	COM0 SEND/RECV instruction end code	When an error occurs when executing the SEND/RECV instruction, the error code is stored.	•	
DT90124	COM1 SEND/RECV instruction end code		•	
DT90125	COM2 SEND/RECV instruction end code		•	
DT90126	Forced ON/OFF operating station display	Used by the system.	•	
DT90127 to DT90139	Reserved for system	-		

Register no.	Name	Description	R	W
DT90140	MEWNET-W0 PLC link 0 status	PLC link 0 No. of times of reception	•	
DT90141		PLC link 0 Reception interval (current value) (x2.5ms)		
DT90142		PLC link 0 Reception interval (minimum value) (x2.5ms)		
DT90143		PLC link 0 Reception interval (maximum value) (x2.5ms)		
DT90144		PLC link 0 No. of times of transmission		
DT90145		PLC link 0 Transmission interval (current value) (x2.5ms)		
DT90146		PLC link 0 Transmission interval (minimum value) (x2.5ms)		
DT90147		PLC link 0 Transmission interval (maximum value) (x2.5ms)		
DT90148	MEWNET-W0 PLC link 1 status	PLC link 1 No. of times of reception	•	
DT90149		PLC link 1 Reception interval (current value) (x2.5ms)		
DT90150		PLC link 1 Reception interval (minimum value) (x2.5ms)		
DT90151		PLC link 1 Reception interval (maximum value) (x2.5ms)		
DT90152		PLC link 1 No. of times of transmission		

## 12.6 List of Special Data Registers

Register no.	Name	Description	R	W
DT90153		PLC link 1 Transmission interval (current value) (x2.5ms)		
DT90154		PLC link 1 Transmission interval (minimum value) (x2.5ms)		
DT90155		PLC link 1 Transmission interval (maximum value) (x2.5ms)		
DT90156	MEWNET-W0	PLC link 0 Work for measuring reception interval	•	
DT90157	PLC link 0 status	PLC link 0 Work for measuring transmission interval		
DT90158	MEWNET-W0	PLC link 1 Work for measuring reception interval	•	
DT90159	PLC link 1 status	PLC link 1 Work for measuring transmission interval		
DT90160	MEWNET-W0 PLC link 0 unit no.	The unit number of PLC link 0 is stored.	•	
DT90161	MEWNET-W0 PLC link 0 Error flag	The error content of PLC link 0 is stored.	•	
DT90162 to DT90169	Reserved for system	-		
DT90170	MEWNET-W0 PLC link 0 status	PLC link address duplicate destination	•	
DT90171		No. of missing tokens		
DT90172		No. of duplicate tokens		
DT90173		No. of no signal states		
DT90174		No. of times of receptions of undefined commands		
DT90175		No. of sum check errors for reception		
DT90176		No. of received data format errors		
DT90177		Number of transmission errors		
DT90178		No. of procedure errors		
DT90179	No. of duplicate master units			
DT90180 to DT90189	Reserved for system	-		

Register no.	Name		Description	R	W
DT90190	Control flag monitor	CH0	[FPsigma mode]	•	
DT90191		CH1	When using the high-speed counter function or pulse output function, the contents set into the data register DT90052 by the F0 (MV) instruction are stored for each channel.	•	
DT90192		CH2		•	
DT90193		CH3		•	
DT90194 to DT90199	Reserved for system		-		
DT90200	Elapsed value area	Low word	[FPsigma mode] The counting area of the pulse output CH2 (Y3, Y4) or the high-speed counter input CH2 (X3).	•	•
DT90201		High word			
DT90202	Target value area	Low word	[FPsigma mode] The target value is set when executing F166 HC1S, F167 HC1R, or pulse output instruction (F17x).	•	
DT90203		High word			



## 12.6 List of Special Data Registers

Register no.	Name		Description	R	W
DT90204	Elapsed value area	Low word	[FPsigma mode] The counting area of the high-speed counter input CH3 (X4).	•	•
DT90205		High word			
DT90206	Target value area	Low word	[FPsigma mode] The target value is set when executing F166 HC1S, F167 HC1R, or pulse output instruction (F17x).	•	
DT90207		High word			
DT90208 to DT90218	Reserved for system		-		

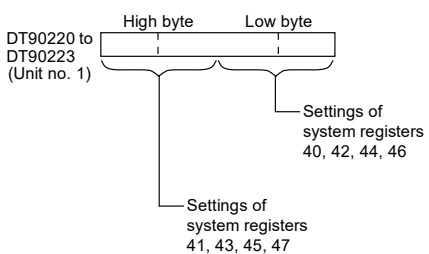
Register no.	Name		Description	R	W
DT90219	Unit number switch of DT90220 to DT90251		0: Unit nos. 1 to 8, 1: Unit nos. 9 to 16	•	
DT90220	PLC link Unit no. 1 or 9	System registers 40 and 41	The settings of the system register related to the PLC link function of each unit number is stored as follows. <Example> When DT90219 is 0; 	•	
DT90221		System registers 42 and 43			
DT90222		System registers 44 and 45			
DT90223		System registers 46 and 47			
DT90224	PLC link Unit no. 2 or 10	System registers 40 and 41	When the system register no. 46 of the home unit is the standard setting, the values in the home unit will be copied for nos. 46 and 47. When the system register no. 46 of the home unit is the reverse setting, the nos. 40 to 45 and 47 corresponding to those of the home unit will be 50 to 55 and 57, and 46 will be set as it is. Also, nos. 40 to 45 corresponding to other units will be the values after correcting the received values, and nos. 46 and 57 of the home unit will be set for nos. 46 and 47.	•	
DT90225		System registers 42 and 43			
DT90226		System registers 44 and 45			
DT90227		System registers 46 and 47			
DT90228	PLC link Unit no. 3 or 11	System registers 40 and 41		•	
DT90229		System registers 42 and 43			
DT90230		System registers 44 and 45			
DT90231		System registers 46 and 47			

## 12.6 List of Special Data Registers

Register no.	Name	Description	R	W
DT90232	PLC link Unit no. 4 or 12	System registers 40 and 41		
DT90233		System registers 42 and 43		
DT90234		System registers 44 and 45		
DT90235		System registers 46 and 47		

Register no.	Name	Description	R	W
DT90236	PLC link Unit no. 5 or 13	System registers 40 and 41		
DT90237		System registers 42 and 43		
DT90238		System registers 44 and 45		
DT90239		System registers 46 and 47		
DT90240	PLC link Unit no. 6 or 14	System registers 40 and 41	<p>The settings of the system register related to the PLC link function of each unit number is stored as follows.</p> <p>&lt;Example&gt;</p> <p>When DT90219 is 0;</p> <p>DT90220 to DT90223 (Unit no. 1)</p> <p>Settings of system registers 40, 42, 44, 46</p> <p>Settings of system registers 41, 43, 45, 47</p>	
DT90241		System registers 42 and 43		
DT90242		System registers 44 and 45		
DT90243		System registers 46 and 47		
DT90244		System registers 40 and 41		
DT90245		System registers 42 and 43		
DT90246		System registers 44 and 45		
DT90247		System registers 46 and 47		

## 12.6 List of Special Data Registers

Register no.	Name		Description	R	W
DT90248	PLC link Unit no. 8 or 16	System registers 40 and 41			
DT90249		System registers 42 and 43			
DT90250		System registers 44 and 45			
DT90251		System registers 46 and 47			
DT90252 to DT90298	Reserved for system		-		
DT90299	Memory configuration mismatch detail		[C32E only] Turns ON the bit corresponding to the function where a memory configuration inconsistency occurred. Bit 0: Logging trace Bit 1: FTP client Bit 4: EtherNet/IP	•	

All the special data registers described in this page are for the FP0H mode.

Register no.	Name		Description	R	W
DT90300	Elapsed value area	Low word	HSC-CH0	•	•
DT90301		High word			
DT90302	Target value area	Low word	HSC-CH0	•	
DT90303		High word			
DT90304	Elapsed value area	Low word	HSC-CH1	•	•
DT90305		High word			
DT90306	Target value area	Low word	HSC-CH1	•	
DT90307		High word			
DT90308	Elapsed value area	Low word	HSC-CH2	•	•
DT90309		High word			
DT90310	Target value area	Low word	HSC-CH2	•	
DT90311		High word			
DT90312	Elapsed value area	Low word	HSC-CH3	•	•
DT90313		High word			
DT90314	Target value area	Low word	HSC-CH3	•	
DT90315		High word			
DT90316 to DT90347	Reserved for system		-		
DT90348	Elapsed value area	Low word	PLS-CH0	•	•
DT90349		High word			

## 12.6 List of Special Data Registers

Register no.	Name		Description	R	W
DT90350	Target value area	Low word	When executing the pulse output instruction (F17x), the target value is set.	•	
DT90351		High word		•	
DT90352	Elapsed value area	Low word	The counting area of the pulse output CH1 (Y2, Y3)	•	•
DT90353		High word		•	•
DT90354	Target value area	Low word	When executing the pulse output instruction (F17x), the target value is set.	•	
DT90355		High word		•	
DT90356	Elapsed value area	Low word	The counting area of the pulse output CH2 (Y4, Y5)	•	•
DT90357		High word		•	•
DT90358	Target value area	Low word	When executing the pulse output instruction (F17x), the target value is set.	•	
DT90359		High word		•	
DT90360	Elapsed value area	Low word	The counting area of the pulse output CH3 (Y6, Y7).	•	•
DT90361		High word		•	•
DT90362	Target value area	Low word	When executing the pulse output instruction (F17x), the target value is set.	•	
DT90363		High word		•	
DT90364 to DT90379	Reserved for system		-		

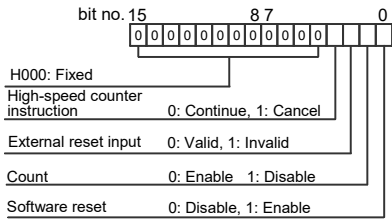
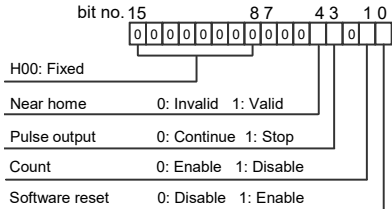
Register no.	Name		Description	R	W
DT90380	High-speed counter function control flag monitor area	HSC-CH0	[FP0H mode]	•	
DT90381		HSC-CH1	When using the high-speed counter function, the contents set into the data register DT90052 by the F0 (MV) instruction are stored for each channel.	•	
DT90382		HSC-CH2		•	
DT90383		HSC-CH3	 <p>bit no. 15                      8 7                      0</p> <p>0 0 0 0 0 0 0 0 0 0 0 0 0 0 0 0 0 0 0 0</p> <p>H000: Fixed</p> <p>High-speed counter instruction    0: Continue, 1: Cancel</p> <p>External reset input    0: Valid, 1: Invalid</p> <p>Count    0: Enable 1: Disable</p> <p>Software reset    0: Disable, 1: Enable</p>	•	
DT90384 to DT90391	Reserved for system		-		
DT90392	Pulse output function control flag monitor area	PLS-CH0	[FP0H mode]	•	
DT90393		PLS-CH1	When using the pulse output function, the contents set into the data register DT90052 by the F0 (MV) instruction are stored for each channel.	•	
DT90394		PLS-CH2		•	
DT90395		PLS-CH3	 <p>bit no. 15                      8 7                      4 3                      1 0</p> <p>0 0 0 0 0 0 0 0 0 0 0 0 0 0 0 0 0 0 0 0</p> <p>H00: Fixed</p> <p>Near home    0: Invalid 1: Valid</p> <p>Pulse output    0: Continue 1: Stop</p> <p>Count    0: Enable 1: Disable</p> <p>Software reset    0: Disable 1: Enable</p>	•	

## 12.6 List of Special Data Registers

Register no.	Name	Description	R	W		
DT90396 to DT90399	Reserved for system	-				
DT90400	Correction speed of initial speed	Low word	PLS-CH0	Set when executing the F171 (SPDH) instruction.	•	
DT90401		High word			•	
DT90402		Low word	PLS-CH1	Set when executing the F171 (SPDH) instruction.	•	
DT90403		High word			•	
DT90404		Low word	PLS-CH2	Set when executing the F171 (SPDH) instruction.	•	
DT90405		High word			•	
DT90406		Low word	PLS-CH3	Set when executing the F171 (SPDH) instruction.	•	
DT90407		High word			•	
DT90408 to DT90499	Reserved for system	-				

Register no.	Name	Description	R	W	
DT90500	SD card recognition flag	The content of WR917 is stored.	•		
DT90501	SD card recognition result	ON: Error OFF: Normal	•		
DT90502	Reserved for system	-	•		
DT90503	SD card capacity	Low word	The capacity of the SD memory card is stored. Unit: kB	•	
DT90504		High word		•	
DT90505	SD card free space	Low word	The free space of the SD memory card is stored. Unit: For SD cards of 2 Gbytes (FAT16), it is always zero.	•	
DT90506		High word		•	
DT90507 to DT90509	Reserved for system	-			
DT90510	SD card internal information	Time acquisition (Year, month) [BCD]	•		
DT90511		Time acquisition (Day, hour) [BCD]	•		
DT90512		Time acquisition (minute, second) [BCD]	•		
DT90513	Vendor code		•		
DT90514	Internal information 1	VUC version	•		
DT90515		Ratio of max. value of number of times of deletion (%)	•		
DT90516	Internal information 2	Ratio of average value of number of times of deletion (%)	•		
DT90517	Internal information 3	Low words	Max. value of number of times of deletion [32-bit]	•	
DT90518		High word		•	
DT90519	Internal information 4	Low words Low long words	Cumulative number of times of deletion [64-bit]	•	
DT90520		High word Low long words		•	

## 12.6 List of Special Data Registers

Register no.	Name		Description	R	W																																				
DT90521		Low words High long words	Cumulative number of times of deletion [64-bit]	•																																					
DT90522		High word High long words	Cumulative number of times of deletion [64-bit]	•																																					
DT90523	Internal information 5		Presence of last recovery processing	•																																					
DT90524	Internal information 6		Cumulative number of times of recovery processing	•																																					
DT90525	Internal information 7	Low words	Cumulative number of swap processing [32-bit]	•																																					
DT90526		High word	Cumulative number of swap processing [32-bit]	•																																					
DT90527	Internal information 8	Low words	Cumulative number of refresh processing [32-bit]	•																																					
DT90528		High word	Cumulative number of refresh processing [32-bit]	•																																					
DT90529	Ethernet communication error code		Saves the error code when the Ethernet communication instruction is executed.	•																																					
DT90530	Result of SD card access instruction execution		<p>Saves the error code when the SD card access instruction is executed.</p> <table border="1"> <tr> <td>0</td> <td>Normal end</td> <td></td> </tr> <tr> <td>1</td> <td>No SD memory card</td> <td>No SD memory card is inserted, or the cover is open.</td> </tr> <tr> <td>2</td> <td>SD memory card write protection</td> <td>The SD memory card is write protected.</td> </tr> <tr> <td>3</td> <td>Specified file name error</td> <td>Code that cannot be specified for a file name is used. There are too many hierarchies for the specified folder.</td> </tr> <tr> <td>4</td> <td>No specified file</td> <td>The specified file does not exist.</td> </tr> <tr> <td>5</td> <td>File already exists</td> <td>The specified file already exists.</td> </tr> <tr> <td>6</td> <td>File read error</td> <td></td> </tr> <tr> <td>7</td> <td>File write error</td> <td>Write protect attributes are set for the specified file.</td> </tr> <tr> <td>8</td> <td>File access position error</td> <td>The reading position or writing position is incorrect.</td> </tr> <tr> <td>9</td> <td>SD memory card capacity shortage</td> <td>Cannot be executed because there is not enough free space on the SD memory card.</td> </tr> <tr> <td>10</td> <td>Reading format error</td> <td>Error in the conversion format when reading a file.</td> </tr> <tr> <td>11</td> <td>File access competition</td> <td>A file that is being logged is specified, or a file that</td> </tr> </table>	0	Normal end		1	No SD memory card	No SD memory card is inserted, or the cover is open.	2	SD memory card write protection	The SD memory card is write protected.	3	Specified file name error	Code that cannot be specified for a file name is used. There are too many hierarchies for the specified folder.	4	No specified file	The specified file does not exist.	5	File already exists	The specified file already exists.	6	File read error		7	File write error	Write protect attributes are set for the specified file.	8	File access position error	The reading position or writing position is incorrect.	9	SD memory card capacity shortage	Cannot be executed because there is not enough free space on the SD memory card.	10	Reading format error	Error in the conversion format when reading a file.	11	File access competition	A file that is being logged is specified, or a file that	•	
0	Normal end																																								
1	No SD memory card	No SD memory card is inserted, or the cover is open.																																							
2	SD memory card write protection	The SD memory card is write protected.																																							
3	Specified file name error	Code that cannot be specified for a file name is used. There are too many hierarchies for the specified folder.																																							
4	No specified file	The specified file does not exist.																																							
5	File already exists	The specified file already exists.																																							
6	File read error																																								
7	File write error	Write protect attributes are set for the specified file.																																							
8	File access position error	The reading position or writing position is incorrect.																																							
9	SD memory card capacity shortage	Cannot be executed because there is not enough free space on the SD memory card.																																							
10	Reading format error	Error in the conversion format when reading a file.																																							
11	File access competition	A file that is being logged is specified, or a file that																																							

## 12.6 List of Special Data Registers

Register no.	Name	Description	R	W																								
		<table border="1"> <tr> <td></td> <td></td> <td>is being accessed via FTP is specified.</td> </tr> <tr> <td>-1 to -99</td> <td>Others</td> <td></td> </tr> </table>			is being accessed via FTP is specified.	-1 to -99	Others																					
		is being accessed via FTP is specified.																										
-1 to -99	Others																											
DT90531 to DT90589	Reserved for system	-																										
DT90590	Details of network errors	<table border="1"> <thead> <tr> <th>Error code</th> <th>Details</th> </tr> </thead> <tbody> <tr> <td>0x0001</td> <td>Hardware fault</td> </tr> <tr> <td>0x0002</td> <td>Memory usage fault</td> </tr> <tr> <td>0x0003</td> <td>Bus fault</td> </tr> <tr> <td>0x0004</td> <td>Usage fault</td> </tr> <tr> <td>0x1001</td> <td>Startup initialization timeout</td> </tr> <tr> <td>0x2001</td> <td>SSL/TLS initialization failed (API)</td> </tr> <tr> <td>0x2002</td> <td>SSL/TLS initialization failed (FTP server)</td> </tr> <tr> <td>0x2003</td> <td>SSL/TLS session generation failed (FTP server)</td> </tr> <tr> <td>0x2004</td> <td>SSL/TLS certificate reading failed (FTP server)</td> </tr> <tr> <td>0x2006</td> <td>SSL/TLS initialization failed (FTP client)</td> </tr> <tr> <td>0x2007</td> <td>SSL/TLS session generation failed (FTP client)</td> </tr> </tbody> </table>	Error code	Details	0x0001	Hardware fault	0x0002	Memory usage fault	0x0003	Bus fault	0x0004	Usage fault	0x1001	Startup initialization timeout	0x2001	SSL/TLS initialization failed (API)	0x2002	SSL/TLS initialization failed (FTP server)	0x2003	SSL/TLS session generation failed (FTP server)	0x2004	SSL/TLS certificate reading failed (FTP server)	0x2006	SSL/TLS initialization failed (FTP client)	0x2007	SSL/TLS session generation failed (FTP client)	•	
Error code	Details																											
0x0001	Hardware fault																											
0x0002	Memory usage fault																											
0x0003	Bus fault																											
0x0004	Usage fault																											
0x1001	Startup initialization timeout																											
0x2001	SSL/TLS initialization failed (API)																											
0x2002	SSL/TLS initialization failed (FTP server)																											
0x2003	SSL/TLS session generation failed (FTP server)																											
0x2004	SSL/TLS certificate reading failed (FTP server)																											
0x2006	SSL/TLS initialization failed (FTP client)																											
0x2007	SSL/TLS session generation failed (FTP client)																											
DT90591	Server certificate storage status	<p>Check the higher 8 bits of the server certificate storage status (DT90591) to find out whether certificates are written by users or not.</p> <table border="1"> <thead> <tr> <th>DT90591 (Higher 8 bits)</th> <th>Status</th> </tr> </thead> <tbody> <tr> <td>0x00</td> <td>User certificate not written</td> </tr> <tr> <td>0x01</td> <td>User certificate written</td> </tr> </tbody> </table>	DT90591 (Higher 8 bits)	Status	0x00	User certificate not written	0x01	User certificate written	•																			
DT90591 (Higher 8 bits)	Status																											
0x00	User certificate not written																											
0x01	User certificate written																											
DT90592 to DT90599	Reserved for system	-																										
DT90600	LOG0 Buffer free space	Stores free space of buffer memory during logging. Unit: kB	•																									
DT90601	LOG1 Buffer free space		•																									
DT90602	LOG2 Buffer free space		•																									
DT90603	LOG3 Buffer free space		•																									
DT90604 to DT90619	Reserved for system	-																										
DT90620	LOG0 Buffer overflow counter	The number of times buffer overflow flags (e.g. R9184 for LOG0) turn on is stored. For checking the number of times logging data is lost during the buffer overflow, register the buffer overflow counter as logging data.	•																									
DT90621	LOG1 Buffer overflow counter		•																									
DT90622	LOG2 Buffer overflow counter		•																									
DT90623	LOG3 Buffer overflow counter		•																									

## 12.6 List of Special Data Registers

Register no.	Name	Description	R	W
DT90624 to DT90639	Reserved for system	-		
DT90640	LOG0 No. of written records of current file	Stores the number of written records in a current file as 16-bit data. Increments the number by one every time data is written in the current file. It is reset to zero when a new file is created.	•	
DT90641	LOG1 No. of written records of current file		•	
DT90642	LOG2 No. of written records of current file		•	
DT90643	LOG3 No. of written records of current file		•	
DT90644 to DT90659	Reserved for system	-		
DT90660	LOG0 No. of files (generations) stored in folder	Stores the number of files stored in a folder (number of generations) as 16-bit data.	•	
DT90661	LOG1 No. of files (generations) stored in folder		•	
DT90662	LOG2 No. of files (generations) stored in folder		•	
DT90663	LOG3 No. of files (generations) stored in folder		•	
DT90664 to DT90679	Reserved for system	-		
DT90680 to DT90681	LOG0 Oldest clock data of file stored in folder	Stores the oldest clock data of a file stored in a folder as 32-bit data in seconds. The clock data is the number of seconds accumulated from 00:00:00 on January 1, 2001.	•	
DT90682 to DT90683	LOG1 Oldest clock data of file stored in folder (Low words)		•	
DT90684 to DT90685	LOG2 Oldest clock data of file stored in folder (Low words)		•	
DT90686 to DT90687	LOG3 Oldest clock data of file stored in folder (Low words)		•	
DT90688 to DT90799	Reserved for system	-		

(Note 1) DT90640 to DT90711 are backed up with a battery.

Register no.	Name	Description	R	W
DT90800	User connection 1 Operation mode	The same value as that in the "Operation mode setting" of the user connection setting in the Ethernet configuration is stored. (When the power turns on, the same value as that in the configuration is set.) When changing data by the 461 CONSET instruction, this area will also be updated. 00h: MEWTOCOL-COM 02h: MODBUS-TCP 03h: MEWTOCOL-DAT 08h: General-purpose communication 10h: MC protocol (AnA compatible 3E frame, binary)	•	
DT90801	User connection 2 Operation mode		•	
DT90802	User connection 3 Operation mode		•	
DT90803	User connection 4 Operation mode		•	
DT90804	User connection 5		•	



## 12.6 List of Special Data Registers

Register no.	Name	Description	R	W
	Operation mode			
DT90805	User connection 6 Operation mode		•	
DT90806	User connection 7 Operation mode		•	
DT90807	User connection 8 Operation mode		•	
DT90808	User connection 9 Operation mode		•	
DT90809 to DT90839	Reserved for system	-	•	
DT90840	User connection 1 SEND/RECV/MTRN done code		•	
DT90841	User connection 2 SEND/RECV/MTRN done code		•	
DT90842	User connection 3 SEND/RECV/MTRN done code		•	
DT90843	User connection 4 SEND/RECV/MTRN done code		•	
DT90844	User connection 5 SEND/RECV/MTRN done code	When specifying the user connection by the F145 (SEND)/F146 (RECV)/F159 (MTRN) instruction, FFFFh is set when the connection is not connected or cut. When completed normally, 0000h is set. For any other values, they vary according to each protocol.	•	
DT90845	User connection 6 SEND/RECV/MTRN done code		•	
DT90846	User connection 7 SEND/RECV/MTRN done code		•	
DT90847	User connection 8 SEND/RECV/MTRN done code		•	
DT90848	User connection 9 SEND/RECV/MTRN done code		•	
DT90849 to DT90889	Reserved for system	-		
DT90890	Slot No.	The slot number specified by the F469 (UNITSEL) instruction is stored. Internal serial: K0, Internal Ethernet: K100 (64h)	•	•
DT90891	Channel No.	The channel number specified by the F469 (UNITSEL) instruction is stored. Internal serial: K0 to K2 (COM0 to COM2)	•	•

## 12.6 List of Special Data Registers

Register no.	Name	Description	R	W
		Internal Ethernet: K1 to K9 (User connections 1 to 9)		
DT90892 to DT90899	Reserved for system	-		
DT90900	Home MAC address	It is the same as the value read by the F465 (ETSTAT) instruction. (3 words) Example: When the MAC address is "00-C0-8F-64-09-18", "00-C0-8F" is vendor ID. It is stored as follows. DT90900: 0918h DT90901: 8F64h DT90902: 00C0h	•	
DT90901			•	
DT90902			•	
DT90903	Reserved for system	-		
DT90904	Home IPv4 address	It is the same as the value read by the F465 (ETSTAT) instruction. (4 words) Example: When the IPv4 address is "192.168.1.5", it is stored as follows. DT90904: 192 DT90905: 168 DT90906: 1 DT90907: 5	•	
DT90905			•	
DT90906			•	
DT90907			•	
DT90908 to DT90999	Reserved for system	-		

## 12.7 List of Basic Instructions

### ■ Seq. basic inst.

Boolean	Name	Step	Remark
ST	Starting logic operation with Form A (normally open) contact <sup>(Note 1)</sup>	1(2)	
DST	Starting logic operation with Form A (normally open) contact: Direct input <sup>(Note 1)</sup>	2	
ST/	Starting logic operation with Form B (normally closed) contact <sup>(Note 1)</sup>	1(2)	
DST/	Starting logic operation with Form B (normally closed) contact: Direct input <sup>(Note 1)</sup>	2	
OT	Outputs operation result <sup>(Note 1)</sup>	1(2)	
DOT	Outputs operation result: Direct input <sup>(Note 1)</sup>	2	
/	Inversion	1	
AN	Serial connection of Form A (normally open) contact <sup>(Note 3)</sup>	1(2)	
DAN	Serial connection of Form A (normally open) contact: Direct input <sup>(Note 1)</sup>	2	
AN/	Serial connection of Form B (normally closed) contact <sup>(Note 3)</sup>	1(2)	
DAN/	Serial connection of Form B (normally closed) contact: Direct input <sup>(Note 1)</sup>	2	
OR	Parallel connection of Form A (normally open) contact <sup>(Note 3)</sup>	1(2)	
DOR	Parallel connection of Form A (normally open) contact: Direct input <sup>(Note 1)</sup>	2	
OR/	Parallel connection of Form B (normally closed) contact <sup>(Note 3)</sup>	1(2)	
DOR/	Parallel connection of Form B (normally closed) contact: Direct input <sup>(Note 1)</sup>	2	
ST ↑	Starting leading contact logic operation	2	
ST ↓	Starting trailing contact logic operation	2	
AN ↑	Leading contact serial connection	2	
AN ↓	Trailing edge serial connection	2	
OR ↑	Leading contact parallel connection	2	
OR ↓	Trailing contact parallel connection	2	
ALT	Alternative out	3	
ANS	Serial connection of multiple instruction blocks	1	
ORS	Parallel connection of multiple instruction blocks	1	
PSHS	Stores operation result	1	
RDS	Reads the operation result stored by the PSHS instruction.	1	
POPS	Reads and clears the operation result stored by the PSHS instruction.	1	

## 12.7 List of Basic Instructions

Boolean	Name	Step	Remark
DF	Leading edge detection	1	
DF/	Trailing edge detection	1	
DFI	Leading edge detection (First scan possible)	1	
SET	Turning output ON and holding <sup>(Note 1)</sup>	3	
DSET	Turning output ON and holding: Direct output <sup>(Note 1)</sup>	3	
RST	Turning output OFF and holding <sup>(Note 1)</sup>	3	
DRST	Turning output Off and holding: Direct output <sup>(Note 1)</sup>	3	
KP	Output accompanied by set/reset input	1	
DKP	Output accompanied by set/reset input: Direct output	2	
NOP	No operation	1	

(Note 1) The instructions that enable the bit index modification.

(Note 2) For the details of the instructions, refer to *FPOH Series Programming Manual (manual no. WUME-FPOHPGR)*.

(Note 3) The values in parentheses listed in the column of Step indicate the number of steps when the index modification is performed, or the device numbers are large (more than R1120, T256 or C256).

### ■ Basic function instructions

Boolean	Name	Step	Remark
TML	On-delay timer (0.001 sec)	3(4)	
TMR	On-delay timer (0.01 sec)	3(4)	
TMX	On-delay timer (0.1 sec)	3(4)	
TMY	On-delay timer (1 sec)	4(5)	
F137 STMR	Auxiliary timer (0.01 sec)	5	
F183 DSTM	Auxiliary timer (32-bit, 0.01 sec)	7	
CT	Down counter	3(4)	
F118 UDC	Up/Down counter	5	
SR	Shift register	1	
F119 LRSR	Left/Right shift register	5	
F182 FILTR	Time constant processing instruction S1, S2, S3, D	9	

(Note 1) For the details of the instructions, refer to *FPOH Series Programming Manual (manual no. WUME-FPOHPGR)*.

(Note 2) The values in parentheses listed in the column of Step indicate the number of steps when the index modification is performed, or the device numbers are large (more than R1120, T256 or C256).

### ■ Control instruction

Boolean	Name	Step	Remark
MC	Master control relay	2	
MCE	Master control relay end	2	

Boolean	Name	Step	Remark
JP	Jumping to a specified label	2	
LOOP	Jumping to a specified label for the number of times set to [D]	4	
LBL	Label for processing JP and LOOP instructions	1	
ED	End of main program area	1	
CNDE	Conditional end	1	
EJECT	NOP operation: Label for page break	2	

(Note 1) For the details of the instructions, refer to *FP0H Series Programming Manual (manual no. WUME-FP0HPGR)*.

(Note 2) The values in parentheses listed in the column of Step indicate the number of steps when the index modification is performed, or the device numbers are large (more than R1120, T256 or C256).

### ■ Step ladder instructions

Boolean	Name	Step	Remark
SSTP	Definition of process	3	
NSTL	Opens a step ladder process. (scan execution type)	3	
NSTP	Transition of process (Pulse type)	3	
CSTP	Clearance of process	3	
STPE	Step ladder area end	1	
SCLR	Clearance of multiple processes	5	

(Note 1) For the details of the instructions, refer to *FP0H Series Programming Manual (manual no. WUME-FP0HPGR)*.

### ■ Subroutine instructions

Boolean	Name	Step	Remark
CALL	Calling specified subroutine	2	
SUB	Definition of subroutine	1(2)	
RET	Exiting subroutine program and returning to main program	1	

(Note 1) For the details of the instructions, refer to *FP0H Series Programming Manual (manual no. WUME-FP0HPGR)*.

### ■ Interrupt instructions

Boolean	Name	Step	Remark
INT	Interrupt program definition	1	
IRET	Ending interrupt program and returning to main program	1	
ICTL	Specifies interrupt control.	5	

(Note 1) For the details of the instructions, refer to *FP0H Series Programming Manual (manual no. WUME-FP0HPGR)*.

## 12.7 List of Basic Instructions

### ■ Program block control instruction

Boolean	Name	Step	Remark
EDPB	End of the program of PBn.	1	

(Note 1) For the details of the instructions, refer to *FP0H Series Programming Manual (manual no. WUME-FP0HPGR)*.

### ■ Special setting instructions

Boolean	Name	Step	Remark
SYS1	Communication parameters, Time setting of end code of communication parameters, Password setting, Interrupt setting, PLC link setting, MEWTOCOL-COM response control, Changing high-speed counter operation mode, Direct unit number setting, Indirect unit number setting, Reading firmware version number	13	
SYS2	System register change instruction	7	

(Note 1) For the details of the instructions, refer to *FP0H Series Programming Manual (manual no. WUME-FP0HPGR)*.

### ■ Comparison contact instructions

Boolean	Name	Step	Remark
ST=	Starting 16-bit data comparison logic operation	5	
ST<>	Starting 16-bit data comparison logic operation	5	
ST>	Starting 16-bit data comparison logic operation	5	
ST>=	Starting 16-bit data comparison logic operation	5	
ST<	Starting 16-bit data comparison logic operation	5	
ST<=	Starting 16-bit data comparison logic operation	5	
AN=	16-bit data comparison serial connection	5	
AN<>	16-bit data comparison serial connection	5	
AN>	16-bit data comparison serial connection	5	
AN>=	16-bit data comparison serial connection	5	
AN<	16-bit data comparison serial connection	5	
AN<=	16-bit data comparison serial connection	5	
OR=	16-bit data comparison parallel connection	5	
OR<>	16-bit data comparison parallel connection	5	
OR>	16-bit data comparison parallel connection	5	
OR>=	16-bit data comparison parallel connection	5	
OR>	16-bit data comparison parallel connection	5	
OR<=	16-bit data comparison parallel connection	5	
STD=	Starting 32-bit data comparison logic operation	9	
STD<>	Starting 32-bit data comparison logic operation	9	

## 12.7 List of Basic Instructions

Boolean	Name	Step	Remark
STD>	Starting 32-bit data comparison logic operation	9	
STD>=	Starting 32-bit data comparison logic operation	9	
STD<	Starting 32-bit data comparison logic operation	9	
STD<=	Starting 32-bit data comparison logic operation	9	
AND=	32-bit data comparison serial connection	9	
AND<>	32-bit data comparison serial connection	9	
AND>	32-bit data comparison serial connection	9	
AND>=	32-bit data comparison serial connection	9	
AND<	32-bit data comparison serial connection	9	
AND<=	32-bit data comparison serial connection	9	
ORD=	32-bit data comparison parallel connection	9	
ORD<>	32-bit data comparison parallel connection	9	
ORD>	32-bit data comparison parallel connection	9	
ORD>=	32-bit data comparison parallel connection	9	
ORD<	32-bit data comparison parallel connection	9	
ORD<=	32-bit data comparison parallel connection	9	
STF=	Starting single-precision floating point data comparison logic operation	10	
STF<>	Starting single-precision floating point data comparison logic operation	10	
STF>	Starting single-precision floating point data comparison logic operation	10	
STF>=	Starting single-precision floating point data comparison logic operation	10	
STF<	Starting single-precision floating point data comparison logic operation	10	
STF<=	Starting single-precision floating point data comparison logic operation	10	
ANF=	Single-precision floating-point data comparison serial connection	10	
ANF<>	Single-precision floating-point data comparison serial connection	10	
ANF>	Single-precision floating-point data comparison serial connection	10	
ANF>=	Single-precision floating-point data comparison serial connection	10	
ANF<	Single-precision floating-point data comparison serial connection	10	
ANF<	Single-precision floating-point data comparison serial connection	10	
ORF=	Single-precision floating-point data comparison parallel connection	10	

## 12.7 List of Basic Instructions

---

Boolean	Name	Step	Remark
ORF<>	Single-precision floating-point data comparison parallel connection	10	
ORF>	Single-precision floating-point data comparison parallel connection	10	
ORF>=	Single-precision floating-point data comparison parallel connection	10	
ORF<	Single-precision floating-point data comparison parallel connection	10	
ORF<=	Single-precision floating-point data comparison parallel connection	10	

(Note 1) For the details of the instructions, refer to *FP0H Series Programming Manual* (manual no. WUME-FP0HPGR).



## 12.8 List of High-level Instructions

### ■ Data transfer instructions

Fun no.	Boolean	Operand	Name	Step	Remark
F0	MV	S, D	16-bit data move	5	
F0	MV	DT90020, D	10 sec ring counter read	5	
F1	DMV	S, D	32-bit data move	7	
F2	MV/	S, D	16-bit data invert and move	5	
F3	DMV/	S, D	32-bit data invert and move	7	
F5	BTM	S, n, D	Bit data move	7	
F6	DGT	S, n, D	Hexadecimal digit data move	7	
F7	MV2	S1, S2, D	Two 16-bit data move	7	
F8	DMV2	S1, S2, D	Two 32-bit data move	11	
F10	BKMV	S1, S2, D	Data block move	7	
F11	COPY	S, D1, D2	16-bit data block copy	7	
F12	ICRD	S1, S2, D	FROM read	11	
P13	PICWT	S1, S2, D	Write to FROM	11	
F15	XCH	D1, D2	16-bit data exchange	5	
F16	DXCH	D1, D2	32-bit data exchange	5	
F176	SWAP	D	Higher and lower byte exchange	3	
F18	BXCH	D1, D2, D3	Data block exchange	7	
F190	MV3	S1, S2, S3, D	Three 16-bit data move	10	
F191	DMV3	S1, S2, S3, D	Three 32-bit data move	16	

(Note 1) For the details of the instructions, refer to *FP0H Series Programming Manual (manual no. WUME-FP0HPGR)*.

### ■ Binary arithmetic instructions

Fun no.	Boolean	Operand	Name	Step	Remark
F20	+	S, D	16-bit data addition [D+S=D]	5	
F21	D+	S, D	32-bit data addition [D+S=D]	7	
F22	+	S1, S2, D	16-bit data addition [S1+S2=D]	7	
F23	D+	S1, S2, D	32-bit data addition [S1+S2=D]	11	
F25	-	S, D	16-bit data subtraction [D-S=D]	5	
F26	D-	S, D	32-bit data subtraction [D-S=D]	7	
F27	-	S1, S2, D	16-bit data subtraction [S1-S2=D]	7	
F28	D-	S1, S2, D	32-bit data subtraction [S1-S2=D]	11	
F30	*	S1, S2, D	16-bit data multiplication [S1*S2=D+1,D]	7	

## 12.8 List of High-level Instructions

Fun no.	Boolean	Operand	Name	Step	Remark
F31	D*	S1, S2, D	32-bit data multiplication [S1*S2=D+3,D+2,D+1,D]	11	
F32	%	S1, S2, D	16-bit data division [S1/S2=D]	7	
F33	D%	S1, S2, D	32-bit data division [S1/S2=D+1,D]	11	
F34	*W	S1, S2, D	16-bit data multiplication [S1*S2=D]	7	
F35	+1	D	16-digit data increment	3	
F36	D+1	D	32-digit data increment	3	
F37	-1	D	16-digit data decrement	3	
F38	D-1	D	32-digit data decrement	3	
F39	D*D	S1, S2, D	32-bit data multiplication [S1*S2=D+1,D]	11	

(Note 1) For the details of the instructions, refer to *FP0H Series Programming Manual (manual no. WUME-FP0HPGR)*.

### ■ BCD arithmetic instructions

Fun no.	Boolean	Operand	Name	Step	Remark
F40	B+	S, D	4-digit BCD data addition [D+S=D]	5	
F41	DB+	S, D	8-digit BCD data addition [D+S=D]	7	
F42	B+	S1, S2, D	4-digit BCD data addition [S1+S2=D]	7	
F43	DB+	S1, S2, D	8-digit BCD data addition [S1+S2=D]	11	
F45	B-	S, D	4-digit BCD data subtraction [D-S=D]	5	
F46	DB-	S, D	8-digit BCD data subtraction [D-S=D]	7	
F47	B-	S1, S2, D	4-digit BCD data subtraction [S1-S2=D]	7	
F48	DB-	S1, S2, D	8-digit BCD data subtraction [S1-S2=D]	11	
F50	B*	S1, S2, D	4-digit BCD data multiplication [S1*S2=D+1,D]	7	
F51	DB*	S1, S2, D	8-digit BCD data multiplication [S1*S2=D+3,D+2,D+1,D]	11	
F52	B%	S1, S2, D	4-digit BCD data division [S1/S2=D]	7	
F53	DB%	S1, S2, D	8-digit BCD data division [S1/S2=D+1,D]	11	
F55	B+1	D	4-digit BCD data increment	3	
F56	DB+1	D	8-digit BCD data increment	3	
F57	B-1	D	4-digit BCD data decrement	3	
F58	DB-1	D	8-digit BCD data decrement	3	

(Note 1) Refer to *FP0H Series Programming Manual (manual no. WUME-FP0HPGR)*.

### ■ Data comparison instruction

Fun no.	Boolean	Operand	Name	Step	Remark
F60	CMP	S1, S2	16-bit data comparison	5	

## 12.8 List of High-level Instructions

Fun no.	Boolean	Operand	Name	Step	Remark
F61	DCMP	S1, S2	32-bit data comparison	9	
F62	WIN	S1, S2, S3	16-bit data band comparison	7	
F63	DWIN	S1, S2, S3	32-bit data band comparison	13	
F64	BCMP	S1, S2, S3	Block data comparison	7	
F373	DTR	S, D	16-bit data revision detection	6	
F374	DDTR	S, D	32-bit data revision detection	6	

(Note 1) Refer to *FP0H Series Programming Manual (manual no. WUME-FP0HPGR)*.

### ■ Logic operation instructions

Fun no.	Boolean	Operand	Name	Step	Remark
F65	WAN	S1, S2, D	16-bit data AND	7	
F66	WOR	S1, S2, D	16-bit data OR	7	
F67	XOR	S1, S2, D	16-bit data exclusive OR	7	
F68	XNR	S1, S2, D	16-bit data exclusive NOR	7	
F69	WUNI	S1, S2, S3, D	[(S1 AND S3) OR (S2 AND S3)=D](16-bit)	9	
F215	DAND	S1, S2, D	32-bit data AND	12	
F216	DOR	S1, S2, D	32-bit data OR	12	
F217	DXOR	S1, S2, D	32-bit data exclusive OR	12	
F218	DXNR	S1, S2, D	32-bit data exclusive NOR	12	
F219	DUNI	S1, S2, S3, D	[(S1 AND S3) OR (S2 AND S3)=D](32-bit)	16	

(Note 1) Refer to *FP0H Series Programming Manual (manual no. WUME-FP0HPGR)*.

### ■ Data conversion instructions

Fun no.	Boolean	Operand	Name	Step	Remark
F70	BCC	S1, S2, S3, D	Block check code (ADD.SUB,XOR,CRC)	9	
F71	HEXA	S1, S2, D	Hexadecimal data -> ASCII code	7	
F72	AHEX	S1, S2, D	ASCII code -> Hexadecimal data	7	
F73	BCDA	S1, S2, D	BCD data -> ASCII code	7	
F74	ABCD	S1, S2, D	ASCII code -> BCD data	7	
F75	BINA	S1, S2, D	16-bit binary data -> ASCII code	7	
F76	ABIN	S1, S2, D	ASCII code -> 16-bit binary data	7	
F77	DBIA	S1, S2, D	32-bit binary data -> ASCII code	11	
F78	DABI	S1, S2, D	ASCII code -> 32-bit binary data	11	
F80	BCD	S, D	16-bit binary data -> BCD data	5	
F81	BIN	S, D	BCD data -> 16-bit binary data	5	
F82	DBCD	S, D	32-bit binary data -> BCD data	7	

## 12.8 List of High-level Instructions

Fun no.	Boolean	Operand	Name	Step	Remark
F83	DBIN	S, D	BCD data -> 32-bit binary data	7	
F84	INV	D	16-bit data inversion	3	
F85	NEG	D	16-bit data sign inversion	3	
F86	DNEG	D	32-bit data sign inversion	3	
F87	ABS	D	16-bit data absolute value	3	
F88	DABS	D	32-bit data absolute value	3	
F89	EXT	D	Sign extension	3	
F90	DECO	S, n, D	Decode	7	
F91	SEGT	S, D	7-segment decode	5	
F92	ENCO	S, n, D	Encode	7	
F93	UNIT	S, n, D	Digit combine	7	
F94	DIST	S, n, D	Digit distribute	7	
F96	SRC	S1, S2, S3	16-bit data search	7	
F97	DSRC	S1, S2, S3, S4	32-bit data search	9	
F230	TMSEC	S, D	Time data -> Second conversion	6	
F231	SECTM	S, D	Second -> Time data conversion	6	
F235	GRY	S, D	16-bit data -> Gray code	6	
F236	DGRY	S, D	32-bit data -> Gray code	8	
F237	GBIN	S, D	Gray code -> 16-bit data	6	
F238	DGBIN	S, D	Gray code -> 32-bit data	8	
F240	COLM	S1, S2, D	Bit line to bit column conversion	8	
F241	LINE	S1, S2, D	Bit column to bit line conversion	8	

(Note 1) Refer to *FP0H Series Programming Manual (manual no. WUME-FP0HPGR)*.

### ■ Data shift instructions

Fun no.	Boolean	Operand	Name	Step	Remark
F100	SHR	D, n	Right shift in 16-bit data	5	
F101	SHL	D, n	Left shift in 16-bit data	5	
F102	DSHR	D, n	Right shift in 32-bit data	5	
F103	DSHL	D, n	Left shift in 32-bit data	5	
F105	BSR	D	Right shift of one hexadecimal digit	3	
F106	BSL	D	Left shift of one hexadecimal digit	3	
F108	BITR	D1, D2, n	Right shift of block area by bit	7	
F109	BITL	D1, D2, n	Left shift of block area by bit units	7	
F110	WSHR	D1, D2	Right shift of one word of block area	5	
F111	WSHL	D1, D2	Left shift of one word of block area	5	

Fun no.	Boolean	Operand	Name	Step	Remark
F112	WBSR	D1, D2	Right shift of one digit of block area	5	
F113	WBSL	D1, D2	Left shift of one digit of block area	5	

(Note 1) Refer to *FP0H Series Programming Manual (manual no. WUME-FP0HPGR)*.

#### ■ Data rotate instructions

Fun no.	Boolean	Operand	Name	Step	Remark
F120	ROR	D, n	16-bit data right rotation	5	
F121	ROL	D, n	16-bit data left rotation	5	
F122	RCR	D, n	16-bit data right rotation with carry flag data	5	
F123	RCL	D, n	16-bit data left rotation with carry flag data	5	
F125	DROR	D, n	32-bit data right rotation	5	
F126	DROL	D, n	32-bit data left rotation	5	
F127	DRCR	D, n	32-bit data right rotation with carry flag data	5	
F128	DRCL	D, n	32-bit data left rotation with carry flag data	5	

(Note 1) Refer to *FP0H Series Programming Manual (manual no. WUME-FP0HPGR)*.

#### ■ Data buffer instructions

Fun no.	Boolean	Operand	Name	Step	Remark
F98	CMPR	D1, D2, D3	Data table shift-out and compress	7	
F99	CMPW	S1, D, S2	Data table shift-in and compress	7	
F115	FIFT	n, D	FIFO buffer definition	5	
F116	FIFR	S, D	Data read from FIFO buffer	5	
F117	FIFW	S, D	Data write to FIFO buffer	5	

(Note 1) Refer to *FP0H Series Programming Manual (manual no. WUME-FP0HPGR)*.

#### ■ Bit manipulation instructions

Fun no.	Boolean	Operand	Name	Step	Remark
F130	BTS	D, n	Specified bit set	5	
F131	BTR	D, n	Specified bit reset	5	
F132	BTI	D, n	Specified bit invert	5	
F133	BTT	D, n	Specified bit test	5	
F135	BCU	S, D	Number of on bits in 16-bit data	5	
F136	DBCD	S, D	Number of on bits in 32-bit data	7	

(Note 1) Refer to *FP0H Series Programming Manual (manual no. WUME-FP0HPGR)*.

## 12.8 List of High-level Instructions

### ■ Special instructions

Fun no.	Boolean	Operand	Name	Step	Remark
F138	HMSS	S, D	Hours, minutes, and seconds data to seconds data	5	
F139	SHMS	S, D	Seconds data to hours, minutes, and seconds data	5	
F140	STC		Carry flag set	1	
F141	CLC		Carry flag reset	1	
F143	IORF	D1, D2	Partial I/O update	5	
F145	SEND	S1, S2, D, N	Data send	9	
F146	RECV	S1, S2, N, D	Data receive	9	
F147	PR	S, D	Printout	5	
F148	ERR	n	Self-diagnostic error code set	3	
F149	MSG	S	Character send to programming tool	13	
F150	READ	S1, S2, n, D	Read shared memory	9	
F151	WRT	S1, S2, n, D	Data write into shared memory	9	
F155	SMPL		Sampling start	1	
F156	STRG		Sampling stop trigger	1	
F157	CADD	S1, S2, D	Calendar data addition	9	
F158	CSUB	S1, S2, D	Calendar data subtraction	9	
F159	MTRN	S, n, D	Serial port send instruction	7	
F160	DSQR	S, D	32-bit data square root	7	

(Note 1) Refer to *FP0H Series Programming Manual (manual no. WUME-FP0HPGR)*.

(Note 2) For the details of F145 (SEND), F146 (RECV) and F159 (MTRN) instructions, refer to *FP0H User's Manual (COM Communication)* and *FP0H User's Manual (Ethernet Communication)*.

### ■ High-speed counter/Pulse output/PWM output instructions

Fun no.	Boolean	Operand	Name	Step	Remark
F0	MV	S, DT90052	High-speed counter control and pulse output control	5	
F1	DMV	S, DT90300	High-speed counter elapsed value read	7	
F1	DMV	DT90300, D	High-speed counter elapsed value write	7	
F1	DMV	S, DT90348	Pulse output elapsed value read	7	
F1	DMV	DT90348, D	Pulse output elapsed value write	7	
F165	CAM0	S	Cam control	3	
F166	HC1S	n, S, D	Target value match on (with channel specification)	11	
F167	HC1R	n, S, D	Target value match off (with channel specification)	11	

## 12.8 List of High-level Instructions

Fun no.	Boolean	Operand	Name	Step	Remark
F171	SPDH	S, n	Pulse output (with channel specification)	5	
F172	PLSH	S, n	Pulse output (with channel specification)	5	
F173	PWMH	S, n	PWM output (with channel specification)	5	
F174	SPOH	S, n	Pulse output (with channel specification)	5	
F175	SPSH	S, n	Pulse output (Linear interpolation)	5	

(Note 1) Refer to *FP0H User's Manual (Positioning/PWM Output/High-speed Counter)*.

### ■ Character string instructions

Fun no.	Boolean	Operand	Name	Step	Remark
F95	ASC	M,D	Character constant -> SCII code conversion	15	
F250	BTOA	S1, S2, S3, D	Multiple binary data -> ASCII codes	12	
F251	ATOB	S1, S2, S3, D	Multiple ASCII codes -> Binary data	12	
F252	ACHK	S1, S2, S3	ASCII data check of multiple ASCII codes	10	
F253	SSET	S1, S2, D	Character constant -> ASCII code (with storage area size)	8 to 264	
F257	SCMP	S1, S2, D	Compares character strings.	10	
F258	SADD	S1, S2, D	Character string coupling	12	
F259	LEN	S, D	Number of characters in a character string	6	
F260	SSRC	S1, S2, D	Search for character string	10	
F261	RIGHT	S1, S2, D	Retrieving data from character strings (right side)	8	
F262	LEFT	S1, S2, D	Retrieving data from character strings (left side)	8	
F263	MIDR	S1, S2, S3, D	Retrieving a character string from a character string	10	
F264	MIDW	S1, S2, S3, D	Writing a character string to a character string	12	
F265	SREP	S, D, P, n	Replacing character strings	12	

(Note 1) Refer to *FP0H Series Programming Manual (manual no. WUME-FP0HPGR)*.

### ■ Data processing instructions

Fun no.	Boolean	Operand	Name	Step	Remark
F270	MAX	S1, S2, D	Maximum value search in 16-bit data block	8	
F271	DMAX	S1, S2, D	Maximum value search in 32-bit data block	8	
F272	MIN	S1, S2, D	Minimum value search in 16-bit data block	8	
F273	DMIN	S1, S2, D	Minimum value search in 32-bit data block	8	
F275	MEAN	S1, S2, D	Total and mean numbers calculation in 16-bit data	8	
F276	DMEAN	S1, S2, D	Total and mean numbers calculation in 32-bit data	8	

## 12.8 List of High-level Instructions

Fun no.	Boolean	Operand	Name	Step	Remark
F277	SORT	S1, S2, S3	Sort data in 16-bit data block	8	
F278	DSORT	S1, S2, S3	Sort data in 32-bit data block	8	
F282	SCAL	S1, S2, D	Linearization of 16-bit data	8	
F283	DSCAL	S1, S2, D	Linearization of 32-bit data	10	
F284	RAMP	S1, S2, S3, D	Inclination output of 16-bit data	10	
F285	LIMIT	S1, S2, S3, D	16-bit data upper and lower limit control	10	
F286	DLIMIT	S1, S2, S3, D	32-bit data upper and lower limit control	16	
F287	BAND	S1, S2, S3, D	16-bit data deadband control	10	
F288	DBAND	S1, S2, S3, D	32-bit data deadband control	16	
F289	ZONE	S1, S2, S3, D	16-bit data zone control	10	
F290	DZONE	S1, S2, S3, D	32-bit data zone control	16	

(Note 1) Refer to *FP0H Series Programming Manual (manual no. WUME-FP0HPGR)*.

### ■ Floating-point data instructions

Fun no.	Boolean	Operand	Name	Step	Remark
F309	FMV	S, D	Floating point data move	8	
F310	F+	S1, S2, D	Floating point data addition	14	
F311	F-	S1, S2, D	Floating point data subtraction	14	
F312	F*	S1, S2, D	Floating point data multiplication	14	
F313	F%	S1, S2, D	Floating point data division	14	
F314	SIN	S, D	Floating point data Sine operation	10	
F315	COS	S, D	Floating point data Cosine operation	10	
F316	TAN	S, D	Floating point data Tangent operation	10	
F317	ASIN	S, D	Floating point data Arcsine operation	10	
F318	ACOS	S, D	Floating point data Arccosine operation	10	
F319	ATAN	S, D	Floating point data Arctangent operation	10	
F320	LN	S, D	Floating point data natural logarithm operation	10	
F321	EXP	S, D	Floating point data exponent operation	10	
F322	LOG	S, D	Floating point data logarithm operation	10	
F323	PWR	S1, S2, D	Floating point data power operation	14	
F324	FSQR	S, D	Floating point data square root operation	10	
F325	FLT	S, D	16-bit integer data -> Floating point data	6	
F326	DFLT	S, D	32-bit integer data -> Floating point data	8	
F327	INT	S, D	Floating point data -> 16-bit integer data (largest integer not exceeding the floating point data)	8	
F328	DINT	S, D	Floating point data -> 32-bit integer data (largest integer not exceeding the floating point data)	8	



## 12.8 List of High-level Instructions

Fun no.	Boolean	Operand	Name	Step	Remark
F329	FIX	S, D	Floating point data -> 16-bit integer data (rounding the first decimal point down to integer)	8	
F330	DFIX	S, D	Floating point data -> 32-bit integer data (rounding the first decimal point down to integer)	8	
F331	ROFF	S, D	Floating point data -> 16-bit integer data (rounding the first decimal point to integer)	8	
F332	DROFF	S, D	Floating point data -> 32-bit integer data (rounding the first decimal point to integer)	8	
F333	FINT	S, D	Floating point data rounding the first decimal point down	8	
F334	FRINT	S, D	Floating point data rounding the first decimal point off	8	
F335	F+/-	S, D	Floating point data sign changes	8	
F336	FABS	S, D	Floating point data absolute	8	
F336	RAD	S, D	Conversion of angle units (Degrees -> Radians)	8	
F338	DEG	S, D	Conversion of angle units (Radians -> Degrees)	8	

(Note 1) Refer to *FP0H Series Programming Manual* (manual no. WUME-FP0HPGR).

### ■ Real number data processing instructions

Fun no.	Boolean	Operand	Name	Step	Remark
F345	FCMP	S1, S2	Floating point data comparison	10	
F346	FWIN	S1, S2, S3	Floating point data band comparison	14	
F347	FLIMIT	S1, S2, S3, D	Floating point data upper and lower limit control	18	
F348	FBAND	S1, S2, S3, D	Floating point data deadband control	18	
F349	FZONE	S1, S2, S3, D	Floating point data zone control	18	
F354	FSCAL	S1, S2, D	Scaling of real number data	12	

(Note 1) Refer to *FP0H Series Programming Manual* (manual no. WUME-FP0HPGR).

### ■ Time series processing instructions

Fun no.	Boolean	Operand	Name	Step	Remark
F355	PID	S	PID operation	4	
F356	EZPID	S1, S2, S3, S4	PID operation: PWM output enable	10	

(Note 1) Refer to *FP0H Series Programming Manual* (manual no. WUME-FP0HPGR).

### ■ Positioning control instruction

Fun no.	Boolean	Operand	Name	Step	Remark
F380	POSST	S1, S2, S3	Positioning table start	8	
F381	JOGST	S1, S2	JOG operation start	6	

## 12.8 List of High-level Instructions

Fun no.	Boolean	Operand	Name	Step	Remark
F382	ORGST	S	Home return start	4	
F383	MPOST	S	Positioning simultaneous start	4	
F384	PTBLR	S1, S2, n, D	Reading positioning parameters	10	
F385	PTBLW	S1, S2, n, D	Writing positioning parameters	10	

(Note 1) Refer to *FP0H Users Manual (Positioning/PWM Output/High-speed Counter)*.

### ■ Logging/trace control instructions

Fun no.	Boolean	Operand	Name	Step	Remark
F420	LOGST	n	Logging trace start request	4	
F421	LOGED	n	Logging Trace Stop Request	4	
F422	LOGSMPL	n	Sampling trace (Ethernet type only)	4	

(Note 1) Refer to *FP0H Users Manual (Logging/Trace Function)*.

### ■ SD card access instruction

Fun no.	Boolean	Operand	Name	Step	Remark
F425	CDTWT	S, n, D	Operation memory file write in BIN format	8	
F426	CDTRD	S, n, D	Data read from BIN format file to operation memory	8	
F427	CWT	S, n, D	File data write instruction	10 to 266	
F428	CRD	S1, S2, n, D	File data read instruction	10 to 266	
F429	CMKDIR	S	Directory creation	4 to 260	
F430	CRMDIR	S	Directory delete	4 to 260	
F431	CRMDIRFL	S	Directory delete (valid for directory with files)	4 to 260	
F432	CFDEL	S	File delete	4 to 260	
F433	CPR	S, D	ASCII data write into file	6 to 518	
F434	CRD1	S, D1, D2	One line read from file	8 to 264	
F435	CREN	S1, S2	File rename	6 to 518	
F436	CCOPY	S1, S2, S3	File copy	8 to 520	
F437	CMV	S1, S2, S3	File move	8 to 520	

## 12.8 List of High-level Instructions

Fun no.	Boolean	Operand	Name	Step	Remark
F438	CFREE	D	Obtainment of SD Memory Card free space: Byte units	4	
F439	CFREEK	D	Obtainment of SD Memory Card free space: KB units	4	
F440	CFLS	S, D	Obtainment of file status	6 to 262	
F441	PanaSD	D1, D2, D3	Panasonic SD Memory Card lifetime information read	8	

(Note 1) Refer to *FP0H Programming Manual (manual no. WUME-FP0HPGR)*.

(Note 2) For the F427 to F437 and F440 instructions, the number of steps differs depending on the specified operands.

### ■ Ethernet communication instructions

Fun no.	Boolean	Operand	Name	Step	Remark
F460	IPv4SET	S	IPv4 address setting	4 to 260	
F461	CONSET	S1, S2, D1, D2	Connection setting	10 to 522	
F462	OPEN	S	Connection open	4	
F463	CLOSE	S	Connection close	4	
F464	RDET	D	Ethernet status read	4	
F465	ETSTAT	S1, S2, D	Ethernet information acquisition	8 to 520	
F469	UNITSEL	S1, S2	Specifying slot port of communication unit	6	

(Note 1) Refer to *FP0H Users Manual (Ethernet Communication)*.

(Note 2) For the F460/F461/F465 instruction, the number of steps varies according to the content specified for the operand.

### ■ FTP client instructions

Fun no.	Boolean	Operand	Name	Step	Remark
F470	FTPcSV	S1, S2, S3	FTP client connected server setting	8 to 776	
F471	FTPcSET	S1, S2, S3, S4	FTP client transfer setting	10 to 1034	
F472	FTPcLOG	S1, S2, S3	Logging / Trace transfer settings	8 to 776	
F473	FTPcREQ	S	FTP client transfer request	4	
F474	FTPcCTL	S1, S2	FTP client transfer control	6 to 518	

(Note 1) Refer to *FP0H Users Manual (Ethernet Communication)*.

## 12.8 List of High-level Instructions

---

(Note 2) For the F470, F471, F472, and F474 instructions, the number of steps differs depending on the specified operands.

## 12.9 List of Error Codes

### 12.9.1 List of Syntax Check Errors

#### Error codes 1 to 8

Code	Name	Operation	Error contents and steps to take
E1	Syntax error	Stop	A program with a syntax error has been written. Change to PROG. mode and correct the error.
E2	Duplicate use (definition) error (Note 1)	Stop	The relay is used in the 'Out' instruction or 'Keep' instruction more than once. It also occurs when using the same timer/counter number. Change to PROG. mode and correct the program so that one relay is not used for two or more instructions. Or, set the duplicated output to "enable" in the system register no. 20. A timer/counter instruction double definition error will be detected even if double output permission has been selected.
E3	Not paired error	Stop	For instructions which must be used in a pair (such as JP and LBL), one instruction is either missing or in an incorrect position. Change to PROG. mode and enter the two instructions which must be used in a pair in the correct positions.
E4	Parameter mismatch error	Stop	An instruction has been written which does not agree with system register settings. The number setting in a program does not agree with the timer/counter range setting. Change to PROG. mode, check the system register settings, and change so that the settings and the instruction agree.
E5	Program area error (Note 1)	Stop	An instruction which must be written in a specific area (main program area or subprogram area) has been written to a different area (for example, a subroutine SUB to RET is placed before an ED instruction). Change to PROG. mode and enter the instruction into the correct area.
E6	Compile memory full	Stop	The program is too large to compile in the program memory. Change to PROG. mode and reduce the total number of steps for the program.
E7	High-level instruction type error	Stop	In the program, high-level instructions, which execute in every scan and at the leading edge of the trigger, are programmed to be triggered by one contact. Correct the program so that the high-level instructions executed in every scan and only at the leading edge are triggered separately.
E8	High-level instruction operand combination error	Stop	There is an incorrect operand in an instruction which requires a specific combination of operands (for example, the operands must all be of a certain type). Enter the correct combination of operands.

(Note 1) The error codes E2 and E5 are detected even when rewriting data with grammatical errors in RUN mode. In this case, nothing will be written into the control unit. The operation continues.

## 12.9 List of Error Codes

### 12.9.2 Self-diagnostic Errors

Code	Name	Operation	Error contents and steps to take
E20	Watchdog timeout	Stop	The watchdog timer is activated and the operation stops. A hardware error or operation congestion occurs. Check if an endless loop occurs by a control instruction which changes the flow of the process of a program (such as JP and LOOP). If there is no problem in the program, there may be an error in the hardware.
E21	MAC address error C32ET/C32EP only	Stop	There may be an error in the hardware. Please contact your dealer.
E22	SD host controller error	Stop	It cannot access the SD card.
E26	User ROM error	Stop	There may be an error in the hardware. Please contact your dealer.
E27	Restrictions on the number of units installed	Stop	The number of the installed units exceeds the limitation. Turn off the power and re-configure units referring to the hardware manual.
E34	I/O status error	Stop	An abnormal unit is installed. Check the slot number with DT90036, and replace the abnormal unit with a normal unit.
E40	I/O error	Select	There may be an error in the function cassette. Check the position where the error occurs with the special data register DT90002 and fix the error.
E41	Extra unit out of control	Select	There may be an error in an intelligent unit. Check the position where the error occurs with the special data register DT90006 and fix the error.
E42	I/O verification error	Select	The I/O unit (expansion unit) wiring condition has changed compared to that at time of power-up. Check the I/O unit whose wiring condition has changed with the special data registers DT90010 and DT90011. Or check the fitting state of the expansion connector.
E43	Configuration data error/ Initialization request error	Select	Configuration data is abnormal. An error occurs in the initialization operation of network. Check the Ethernet setting and EtherNet/IP setting.
E44	Positioning operation error occurred	Select	The error when using the table operation function occurs. The set parameter may be incorrect or the limit error may occur. Check if the parameter is in the settable range. The channel and content where the positioning operation error occurs can be confirmed by pressing the [Positioning error] button in the status display dialog box.
E45	Operation error occurred	Select	In executable operation error occurs. The address of the operation error can be confirmed by either special data registers DT90017 or DT90018. In the tool software, it can also be checked with the [Operation errors] button in the status display dialog box.
E46	Network error occurred	Select	An error occurs in the network operation. Check the Ethernet setting and EtherNet/IP setting. For details of network errors, check the special data register No. DT90590.

## 12.9 List of Error Codes

Code	Name	Operation	Error contents and steps to take
E48	System register setting error	Operation stops	The setting value of a system register is abnormal. Check the setting again. Example) The error occurs when the range of the data registers or internal relays set in the system register no. 0 or no. 1 are inconsistent with the settings of hold/non-hold area in the system register no. 7 or no.8, or the buffer area setting for the general-purpose communication in the system register nos. 416 to 423. The system register number can be confirmed by the special register DT90007.
E50	Battery error (A battery comes off or the voltage drops.)	Operation continues	The voltage of the backup battery lowered or the backup battery is not installed in the control unit. Check the backup battery, and replace or connect it if necessary. This self-diagnostic error can be set to be notified or not by the system register no. 4.
E51	RTC error	Operation continues	An error in the clock data of the clock/calendar was detected.
E59	Memory configuration inconsistency	Operation continues	An inconsistency was detected in the memory configuration for logging trace, FTP client, or EtherNet/IP.
E60	Logging setting mismatch (when loading logging settings from an SD card)	Operation continues	An error has been detected in logging data settings.
E61	Logging data error	Operation continues	An error was detected in checking the logging setting when the power turned on.
E62	SNTP time acquisition failure	Operation continues	The acquisition of time data has failed during time synch via LAN port.
E63	Logging/trace registration error	Stop	An error occurs in the logging/trace register/delete command for the MEWTOCOL communication. Check the command format and the registered/deleted content.
E64	Incorrect project data	Stop	An error was detected in checking the project data when the power turned on. All programs and security information will be deleted and the PLC will be initialized.
E65	Auto-run definition file error	Stop	There is an error in the auto-run definition file error. Or, there is no transfer file described in the auto-run definition file.
E70	SD card copy failed: Cover opened	Stop	The copy cannot be executed because the card cover is open. Close the cover.
E71	SD card copy failed: No SD card	Stop	The copy cannot be executed because there is no SD memory card. Insert an SD memory card.
E72	SD card copy failed: SD card operation disabled: SD card	Stop	The copy cannot be executed because the SD memory card is broken. Insert a normal SD memory card.

## 12.9 List of Error Codes

Code	Name	Operation	Error contents and steps to take
	reading error (FAT/File error)		
E73	SD card copy failed: No file	Stop	The copy cannot be executed because there is no file in the SD memory card. Check if any project file is stored.
E74	SD card copy failed: Password unmatched (Limited distribution function)	Stop	The copy cannot be executed because the password for the project file stored in the SD memory card does not coincide with the password for the execution project stored in the internal ROM. Check the password setting.
E75	SD card copy failed: Incorrect project data	Stop	The copy cannot be executed because the project data stored in the SD memory card is abnormal. Check the contents of the project data.
E100 to E199	Self-diagnostic error set by F148	Stop	An error that has been arbitrarily set by the high-level instruction F148 occurs. Take countermeasures according to the specified detection condition.
E200 to E299		Operation continues	

(Note 1) The error codes 43 to 299 can be cleared by pressing the [Clear errors] button in the status display dialog box of the programming tool or by the F148 (ERR) instruction (clearing a self-diagnostic error by specifying K0).

### 12.9.3 List of MEWTOCOL-COM Communication Error Codes

Code	Name	Description of error
!26	Unit number setting error	A command that cannot be used for global (unit no. FF) was received.
!40	BCC error	Transmission error occurred in received data.
!41	Format error	Command that does not match the format was received.
!42	NOT support error	An unsupported command was received.
!43	Multiframe process error	Another command was received during the multiframe processing.
!60	Parameter error	Specified parameter does not exist, or cannot be used.
!61	Data error	There is an error in the contact, data area, data number, size, range or format specification.
!62	Registration over error	The number of registration exceeded the restriction, or operation is performed without registration.
!63	PC mode error	Invalid command was executed in RUN mode or when copying data in an SD memory card.
!64	External memory error	There is an abnormality in hardware. There may be an abnormality in the internal ROM (F-ROM). At the time of ROM transfer, a specified content exceeds the capacity. A reading/writing error occurred.
!65	Protection error	Write operation was performed to a program or system register when the unit is protected (password setting).



## 12.9 List of Error Codes

---

Code	Name	Description of error
!66	Address error	The code format of address data is incorrect, or the range specification is incorrect.
!67	Missing program error /Missing data error	Reading message or starting/reading sampling trace was executed when no program/data is registered.
!68	Rewriting is disabled while in RUN mode	Editing an instruction that cannot be rewritten in RUN mode (ED, SUB, RET, INT, IRET, SSTP or STPE) is attempted. Nothing is written to the CPU.
!71	Exclusive control error	A command that cannot be processed simultaneously with the command in process was executed.
!78	No SD card error	SD card is not inserted.
!80	Guarantee data abnormality error	Guarantee data (CRC code) is incorrect.
!81	No effective data error	There is no effective data.
!90	Logging trace error	Invalid command was executed during the logging trace operation.
!92	Unsupported SD card error	The card is not an industrial SD card manufactured by Panasonic.
!93	Server disabled error	A command was executed when the target server was disabled.
!94	Certificate writing error	Certificate was written using illegal procedure.
!97	Server connected error	A command was executed when the target server was connected.

## 12.10 Dimensions

### 12.10 Dimensions

#### 12.10.1 AFP0HC32T/AFP0HC32P

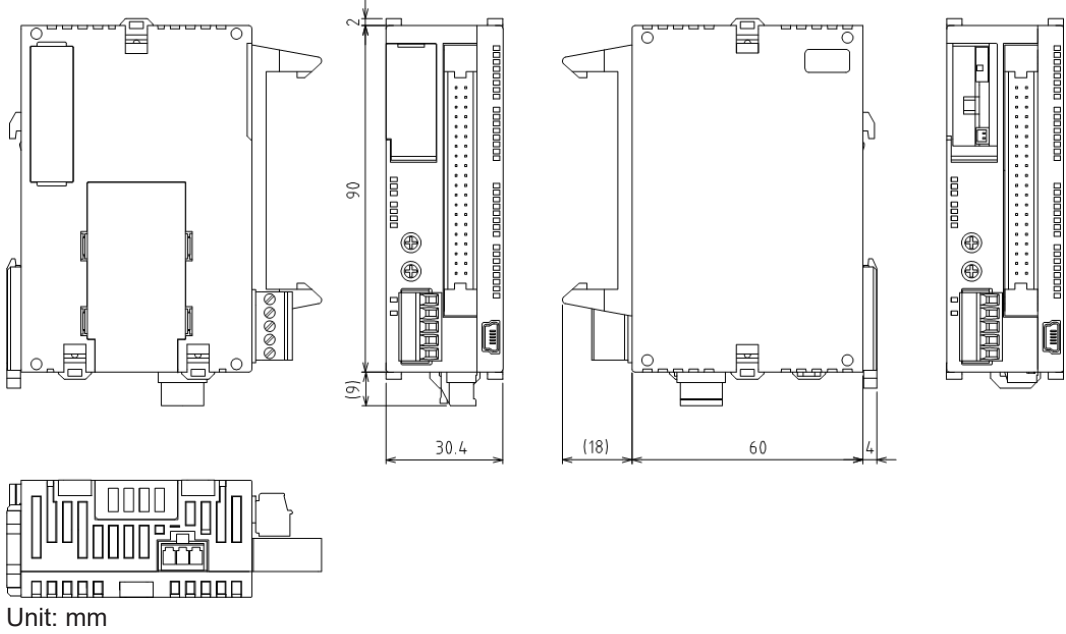

#### 12.10.2 AFP0HC32ET/AFP0HC32EP

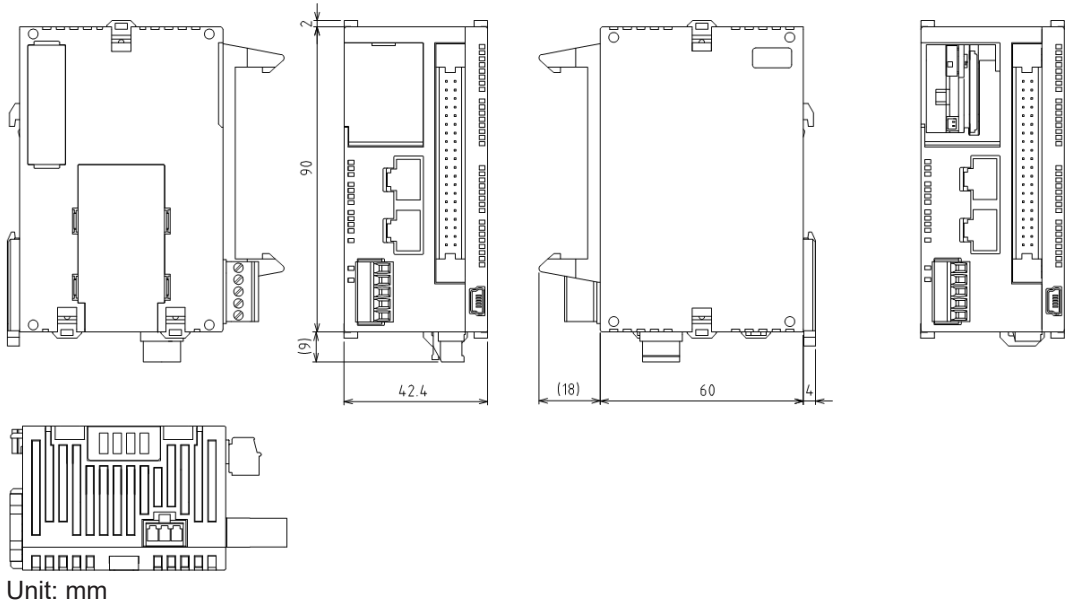

## Record of changes

Manual number can be found at the bottom of the cover page.

Date	Manual No.	Record of Changes
Oct. 2017	WUME-FP0HBAS-01	1st Edition
Feb. 2018	WUME-FP0HBAS-02	2nd Edition Version upgrade of the unit firmware (Ver.1.1) Added the descriptions of supported functions. <ul style="list-style-type: none"> <li>● FPsigma mode</li> </ul>
Jun. 2018	WUME-FP0HBAS-03	3rd Edition Added descriptions related to the functions supported for the main unit firmware upgraded to Ver. 1.2 <ul style="list-style-type: none"> <li>● SD card access instruction</li> <li>● FTP server and FTP client functions</li> <li>● COM baud rates (1200 and 2400 bps) added</li> <li>● Memory configuration mismatch detection</li> <li>● Strengthened password input restriction</li> </ul> FP0H expansion unit (AFP0HXY64D2P) added
Jan. 2019	WUME-FP0HBAS-04	4th Edition Upgrading the firmware version of the main unit (Ver. 1.3) Addition of description about supported functions <ul style="list-style-type: none"> <li>● Addition of self-diagnosis error codes</li> <li>● Addition of special relays</li> <li>● Addition of special data registers</li> </ul>
Apr. 2019	WUME-FP0HBAS-05	5th Edition FP0H Positioning Unit RTEX added
Apr. 2020	WUME-FP0HBAS-06	6th Edition Changed the format Errors corrected
Feb. 2021	WUME-FP0HBAS-07	7th Edition Updated the contents to reflect version upgrade (Ver1.10) of FP0H RTEX. Corrected errors.
Mar.2021	WUMJ-FP0HBAS-08	8th Edition Revised description due to discontinuation of the Panasonic SD memory cards and SDHC memory cards.
June 2021	WUME-FP0HBAS-09	9th Edition Revised due to a version upgrade of the FP0H firmware (Ver. 1.8)
December 2021	WUME-FP0HBAS-10	10th Edition Revised due to a version upgrade of the FP0H firmware (Ver. 1.9)

Date	Manual No.	Record of Changes
		<ul style="list-style-type: none"> <li>Added system register no. 438 "Update inputs status when the power is turned on".</li> </ul>
July 2022	WUME-FP0HBAS-11	11th Edition Added descriptions on the replacement time of the backup battery.

## Order Placement Recommendations and Considerations

The Products and Specifications listed in this document are subject to change (including specifications, manufacturing facility and discontinuing the Products) as occasioned by the improvements of Products. Consequently, when you place orders for these Products, Panasonic Industrial Devices SUNX asks you to contact one of our customer service representatives and check that the details listed in the document are commensurate with the most up-to-date information.

### [Safety precautions]

Panasonic Industrial Devices SUNX is consistently striving to improve quality and reliability. However, the fact remains that electrical components and devices generally cause failures at a given statistical probability. Furthermore, their durability varies with use environments or use conditions. In this respect, check for actual electrical components and devices under actual conditions before use. Continued usage in a state of degraded condition may cause the deteriorated insulation. Thus, it may result in abnormal heat, smoke or fire. Carry out safety design and periodic maintenance including redundancy design, design for fire spread prevention, and design for malfunction prevention so that no accidents resulting in injury or death, fire accidents, or social damage will be caused as a result of failure of the Products or ending life of the Products.

The Products are designed and manufactured for the industrial indoor environment use. Make sure standards, laws and regulations in case the Products are incorporated to machinery, system, apparatus, and so forth. With regard to the mentioned above, confirm the conformity of the Products by yourself.

Do not use the Products for the application which breakdown or malfunction of Products may cause damage to the body or property.

- i) usage intended to protect the body and ensure security of life
- ii) application which the performance degradation or quality problems, such as breakdown, of the Products may directly result in damage to the body or property

It is not allowed the use of Products by incorporating into machinery and systems indicated below because the conformity, performance, and quality of Products are not guaranteed under such usage.

- i) transport machinery (cars, trains, boats and ships, etc.)
- ii) control equipment for transportation
- iii) disaster-prevention equipment / security equipment
- iv) control equipment for electric power generation
- v) nuclear control system
- vi) aircraft equipment, aerospace equipment, and submarine repeater
- vii) burning appliances
- viii) military devices
- ix) medical devices (except for general controls)
- x) machinery and systems which especially require the high level of reliability and safety

### [Acceptance inspection]

In connection with the Products you have purchased from us or with the Products delivered to your premises, please perform an acceptance inspection with all due speed and, in connection with the handling of our Products both before and during the acceptance inspection, please give full consideration to the control and preservation of our Products.

### [Warranty period]

Unless otherwise stipulated by both parties, the warranty period of our Products is 3 years after the purchase by you or after their delivery to the location specified by you. The consumable items such as battery, relay, filter and other supplemental materials are excluded from the warranty.

### [Scope of warranty]

In the event that Panasonic Industrial Devices SUNX confirms any failures or defects of the Products by reasons solely attributable to Panasonic Industrial Devices SUNX during the warranty period, Panasonic Industrial Devices SUNX shall supply the replacements of the Products, parts or replace and/or repair the defective portion by free of charge at the location where the Products were purchased or delivered to your premises as soon as possible.

However, the following failures and defects are not covered by warranty and we are not responsible for such failures and defects.

- (1) When the failure or defect was caused by a specification, standard, handling method, etc. which was specified by you.
- (2) When the failure or defect was caused after purchase or delivery to your premises by an alteration in construction, performance, specification, etc. which did not involve us.
- (3) When the failure or defect was caused by a phenomenon that could not be predicted by the technology at purchasing or contracted time.
- (4) When the use of our Products deviated from the scope of the conditions and environment set forth in the instruction manual and specifications.
- (5) When, after our Products were incorporated into your products or equipment for use, damage resulted which could have been avoided if your products or equipment had been equipped with the functions, construction, etc. the provision of which is accepted practice in the industry.
- (6) When the failure or defect was caused by a natural disaster or other force majeure.
- (7) When the equipment is damaged due to corrosion caused by corrosive gases etc. in the surroundings.

The above terms and conditions shall not cover any induced damages by the failure or defects of the Products, and not cover your production items which are produced or fabricated by using the Products. In any case, our responsibility for compensation is limited to the amount paid for the Products.

### [Scope of service]

The cost of delivered Products does not include the cost of dispatching an engineer, etc. In case any such service is needed, contact our sales representative.

Panasonic Industrial Devices S U N X Co., Ltd.

(MEMO)

(MEMO)

---

**Panasonic Industry Co., Ltd.**  
**Panasonic Industrial Devices SUNX Co., Ltd.**  
<https://panasonic.net/id/pidsx/global>

Please visit our website for inquiries and about our sales network.

Panasonic Industrial Devices SUNX Co.,Ltd. 2022  
July 2022

WUME-FPOHBAS-11