



The Voltage Regulator System for Transformers with Tap-changer

Features:

- △ multifunctional voltage regulator
- △ integrated transducer and recorder functions
- △ integrated statistical functions to measure and evaluate operation data
- △ several programs for parallel operation of transformers
- △ take over of tasks from the working area of the transformer



REGSys – The Digital Voltage Regulator System

Temporal Development

In many fields of electrical engineering, new developments are based on practical experiences made in the past. Without this „know-how“ acquired over decades from preceding types like REG - 10/9/5A/5E, the development of this regulator system REGSys would not have been possible.

This very new concept of REGSys does not only cover the standard tasks of the voltage regulation on transformers with tap changer but also offers a wide range of special features.

Structure

REGSys includes several basic components.

The voltage regulator REG - D assumes as well as the regulation of the transformer voltage, the measuring, recording and statistical functions in order to supervise the operation.

The monitoring unit PAN - D redundantly supervises the voltage regulation and the tap-changer.

The components ANA - D and BIN - D (interface components) increase the number of analogue and binary inputs and outputs of the regulator.

The use of additional function units widens the application range considerably.

The connection of autonomous voltage regulators via bus to a system (multimaster system architecture) permits a central supervision of the transformers and a mutual data exchange over long distances. Different ways of transmission can be chosen.

Parameter Setting

The parameter setting can either be made directly via keyboard or via PC. For this reason and for the connection to a control station each regulator is equipped with two serial interfaces.

Supervision and Recording

The voltage course is stored continuously or event-controlled in the regulator and can be shown as a line diagram on the display or printed as a data list. The memory stores a period of approximately one month on average.

The statistical function records the total number of all switching operations of the tap-changer. Furthermore the number of switching operations under load and how many times each tap position has been in operation are indicated.

Characteristics of the REGSys

- statistical functions
- measuring functions (U, I, P, S, cos φ , ...)
- recorder functions (controlled by limit value, event)
- parallel operation of transformers without any additional components
- supervision of the voltage regulator and the tap-changing functions
- multimaster system architecture with up to 255 bus subscribers at different bus topologies
- connection to latest control systems via serial interface RS232/LWL
- free programmable analogue and binary inputs and outputs
- periphery bus RS485 for the connection to interface components
- WinREG - software for parameter setting, programming and visualisation
- REGSim - software for the simulation of any parallel operation, net and load depending situations
- integrated tap-changer indication
- free choice of programmable set point values for the voltage
- programmable rated values of U and I
- supervision of phase sequence and phase failure

Please note, that the Language of the menu can also be supplied in English, French, Spanish and Italian.

Menu-guide to each application

The desired display modes can be chosen by pressing the corresponding function buttons:

Menu Selection

A:Tr_101 09:24:56	
REGULATOR	TRANSUDCER MODE
RECORDER	STATISTICS
PARAGRAME	SETUP: <MENU>

Regulator Mode

A:Tr_101 09:24:56	
Regulator Mode AUTO	
1. SetPoint	100.0 %
Act. Value	16.5 kV
Bandwidth	16.8 kV
Current	2.0 %
Tap-Changer Pos	160.0 A
-10% 0 +10%	
.....!.....!.....!.....!	
A	

Transducer Mode

A:Tr_101 09:24:56	
Transducer Mode	
U =	20.00 kV
[1A] I =	600.00 A
P =	19.53 MW
Q =	7.11 MVar
S =	20.78 MVA
cos φ	0.94
φ	-20.0 ° ind
I * sin φ	-205.21 A
f	50.00 Hz

A:Tr_101 09:24:56	
9.60kV	10.40kV
dt	
dt=1ks	
9.96 kV	09:24:56
TCPos 12	22.07.99

A:Tr_101 09:24:56		
STATISTICS		
Total Amount	:	85
Tap-Changes Under Load	:	63
0	:	0
1	:	4
2	:	12
3	:	23
4	:	15
5	:	4
6	:	5
7	:	0
8	:	0
9	:	0
10	:	0
11	:	0
← →: next/Prev. Page		

A:Tr_101 09:24:56	
Par. Parameter..	
Parallel Program:	di * sin(Phi)
Time Behaviour:	LINEAR
Current Influence	none
LDC Parameter	

Recorder Mode

Statistics Mode

Parameter Mode

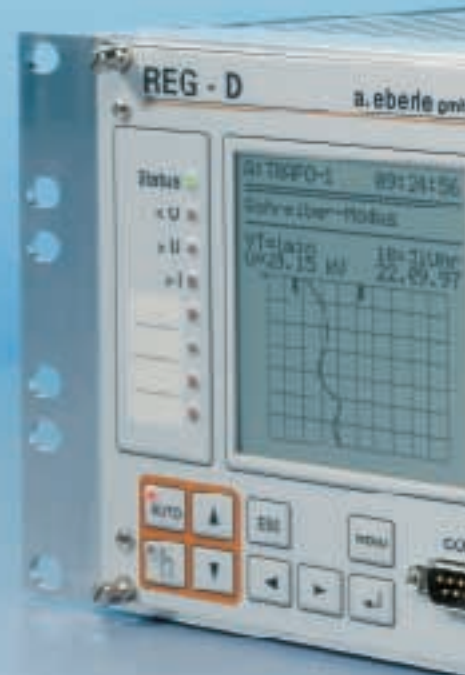

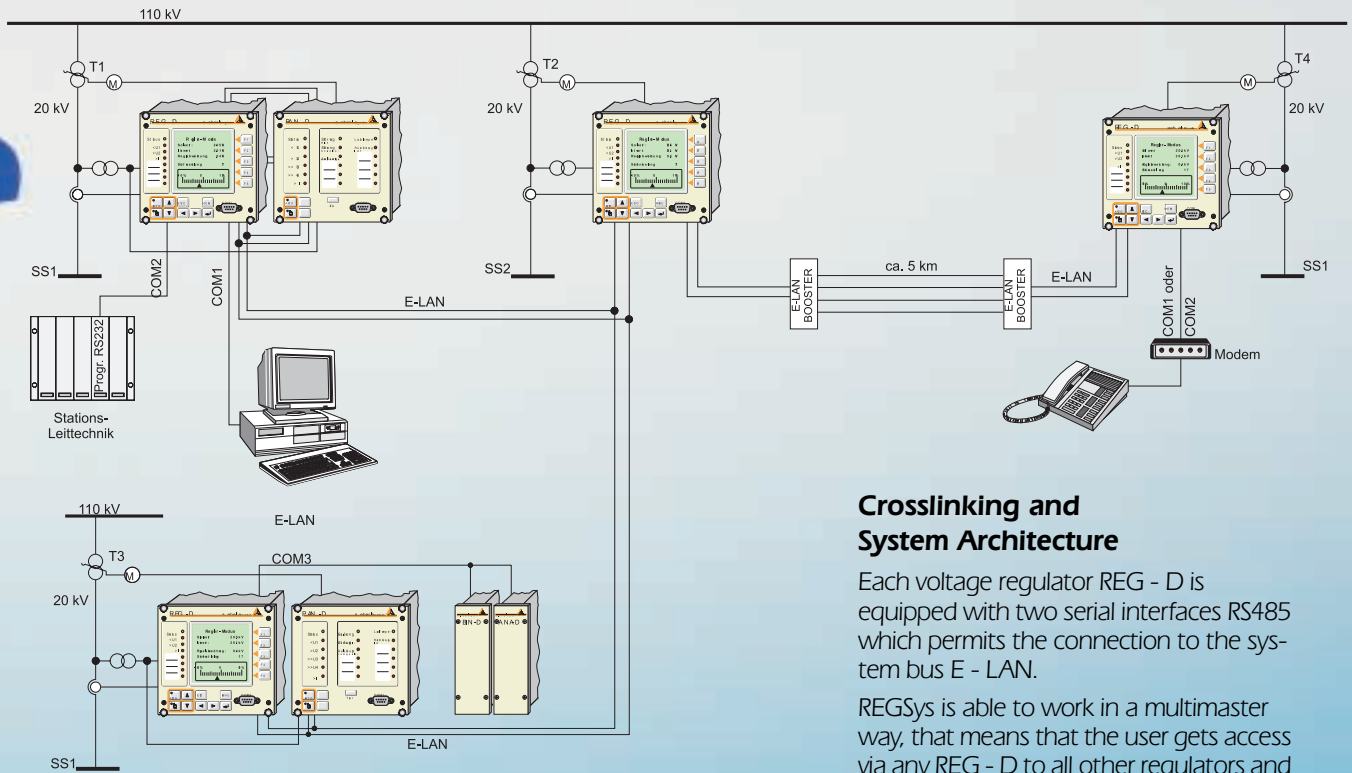

Crosslinking and System Architecture

Each voltage regulator REG - D is equipped with two serial interfaces RS485 which permits the connection to the system bus E - LAN.

REGSys is able to work in a multimaster way, that means that the user gets access via any REG - D to all other regulators and monitoring units PAN - D which are connected to the bus. This makes a remote parameter setting and centralised visualisation of regulator groups possible.

Up to 255 subscribers are permitted on the network for the topologies „bus“, „line to line“ and „star“.

The crosslinking of several regulators is above all for the parallel operation of the transformers necessary. Even difficult parallel operations can be smartly solved in this way (please, also refer to page 5).



Demanding Tasks – Optimally Solved ...

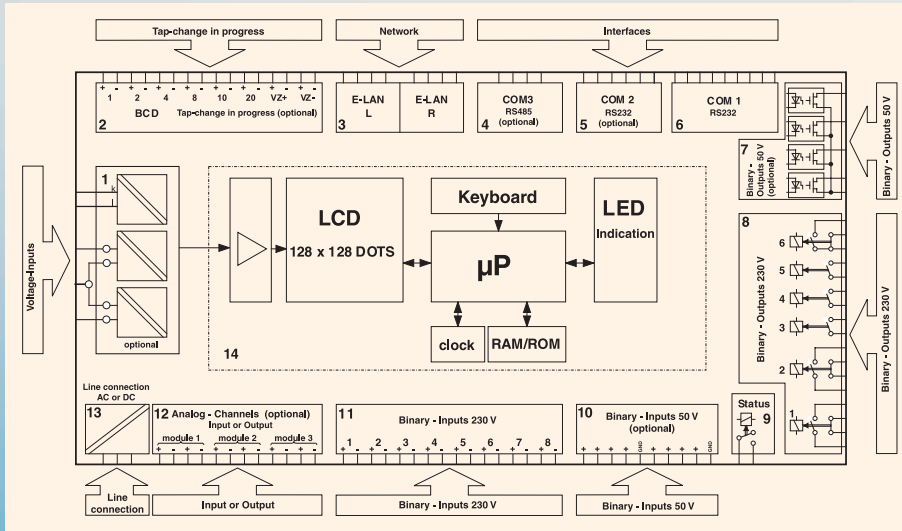

Almost every task arising on transformers with tap changer can be solved by REGSys.

Moreover, the requirements of the corresponding area can also be included in the system configuration.

Programmable interface components are available in the regulator REG - D; they can be used for the input and output of analogue and digital signals from the periphery of the transformer.

Such a complete task-solving solution can be realised with REGSys without any additional hardware and without any additional efforts from the operator.

The adaptation to each corresponding operating condition can be made via WINDOWS-software WinREG and via the implemented interpreter programming language REG - L in the regulator.

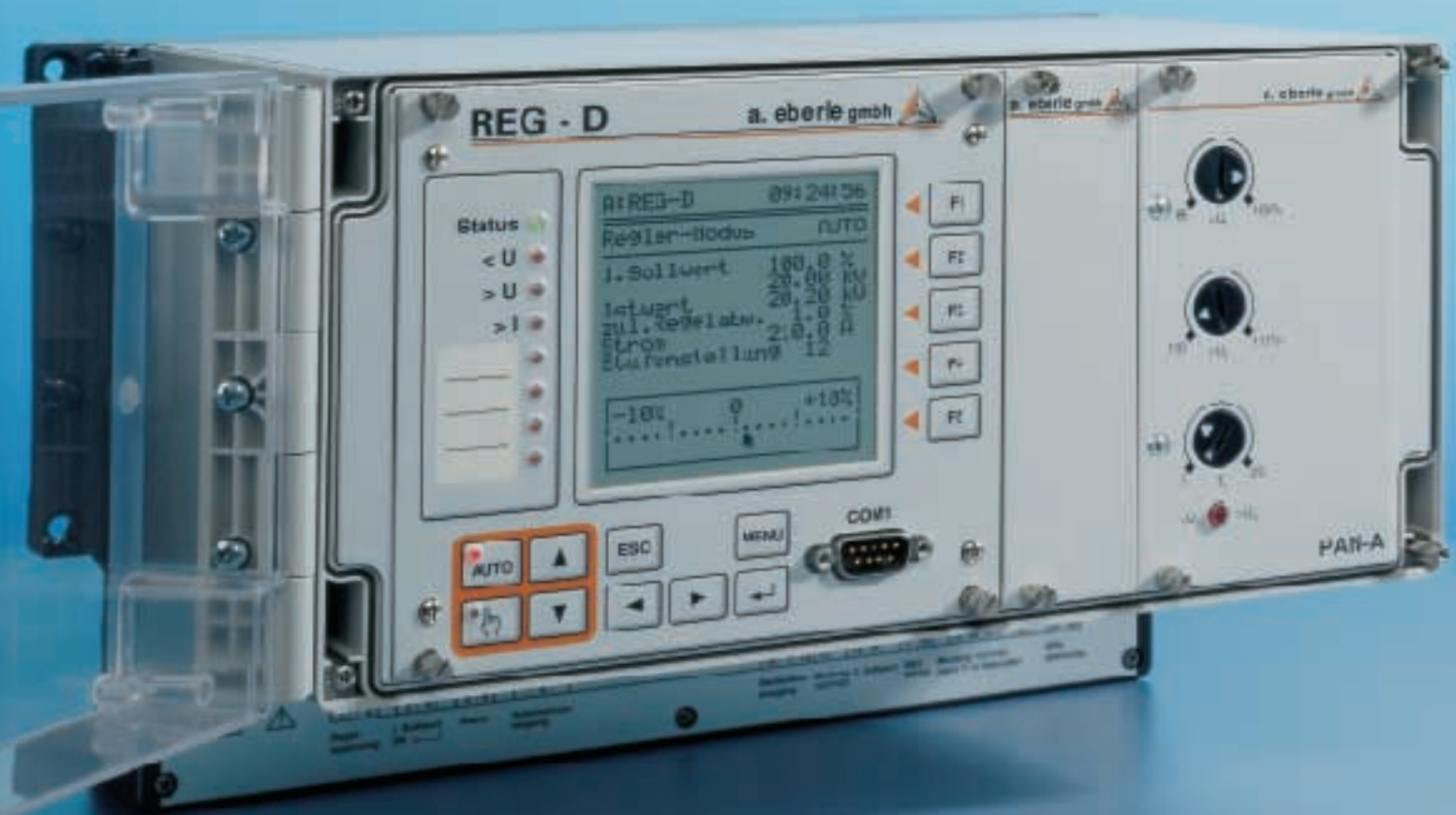

with application software WinREG and simulation software REGSim

Parallel Operating Transformers

The operation of transformers in parallel is being made via regulator bus (E - LAN). Depending on the data of the transformers (rated power, tap-change, short-circuit voltage), adapted parallel operating switching programs are used. (For the selection of programs, please refer to REGSim).

WinREG

Software WinREG makes the parameter setting and the programming of the system possible.

Parameter Mode enables all settings of the components REG - D and PAN - D by simple, file like index cards, following the same steps as via the functions keys on REG - D.

Preparations for the initial operation can be made in the office (off-line) and the existing data file can be loaded „on site“. Only a few modifications will then be necessary for the optimal adjustment of the parameters to the working conditions.

The final data file with all parameters for the REG - D can be transferred to a PC and then filed and used for similar cases.

In Panel Mode up to six voltage regulators can be shown on the PC simultaneously, arranged in any order and stored.

REGSim

Software REGSim enables the user to simulate a voltage regulation of parallel operating transformers under real working conditions.

Therefore, the following parameters can be put in or changed:

Transformer: S_{Tr} , X, R and the gradient; line: X and R; load: I_{act} , I_{react} and the rated voltage.

All possible settings of the simulated regulator correspond to those of the regulator REG - D.

Beside the standard procedures like „ $\Delta I \sin \varphi$ circulating reactive current compensation“ and the „Master-Slave-Principle“, new programs such as „ $\Delta I \sin \varphi (S)$ and $\Delta I'$ “ have been created to minimise the circulating reactive currents.

The approved procedure „ $\Delta \cos \varphi$ “ will be used for parallel operating transformers in a high voltage net, without any bus link between the placed transformers.

A remote controlled operation via PC is possible when all REGSys components are linked via E - LAN (RS485). It also allows the questioning and parameter change of each single component of REG - D and PAN - D.

In Terminal Mode, any required application program can be established on-line and activated. The necessary command for the programming language REG - L (Interpreter) is already available in the regulator. Likewise parameters for voltage regulators connected to a bus can be changed, too, if the authorisation for the use of this software (password) is given.

The Recorder Mode allows the evaluation of the stored measured values in REG - D as well as the visualisation via PC. A conversion of this file into an Excel-file is possible which offers individual evaluation.

The effects of different regulator settings and extreme working conditions of the three-phase system on the regulation are simulated in real time.

The optimal values measured in REGSim can be loaded afterwards via WINReg into the regulator.

As data exchange with WINReg is possible, parameters of the regulator can be made at the desk and then simulated and stored.

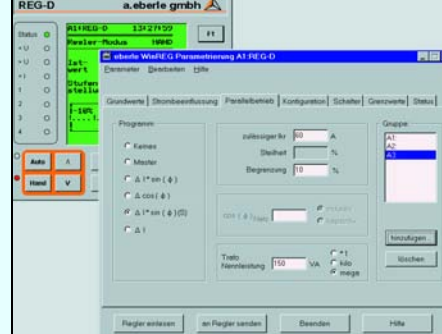

Parameter-Mode

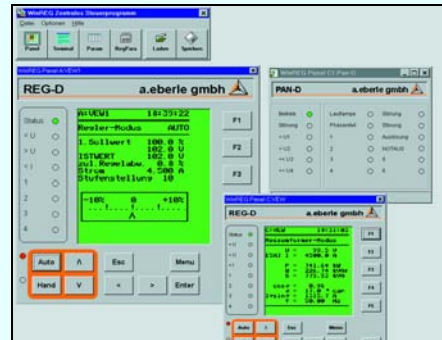

Panel-Mode

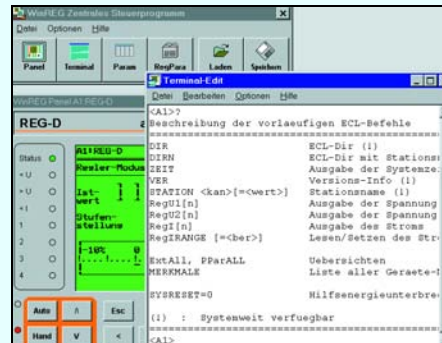

Terminal-Mode



REGSim

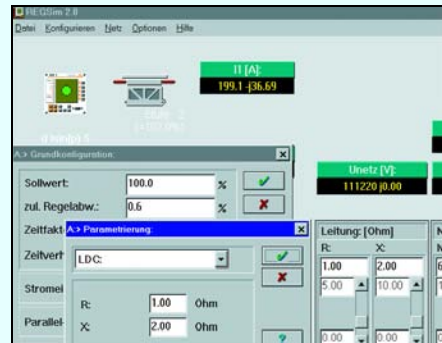

REGSim

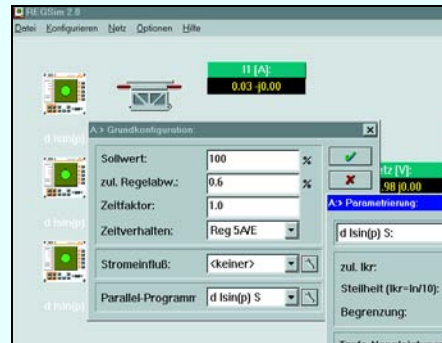

REGSim

REGSys - overview

Type Application / Description / Technical Data

Voltage regulator REG - D



The voltage regulator works autonomously. The set point and actual value, the regulative deviation as well as the tap-change position are shown on the display (LCD). Moreover the net quantity values, the temporal course of the net voltage, either continuously or after an event or the number and the kind of switching operations made can also be displayed. Binary and analogue signals can be edited via firm and freely programmable inputs

and outputs external signals can be put in, displayed and processed.
 Net quantities: U_E : 80 V ... 120 V; I_E : 1/5 A
 Number of binary inputs: 8 + 8
 Number of binary outputs: 4 + 1 + 6
 Number of analogue inputs/outputs: 6
 Power supply:
 AC: 85 V ... 264 V or
 DC: 18 V ... 72 V or 100 V ... 375 V
 plug-in unit, width 28 TE (modules)

Monitoring unit PAN - D PAN - A

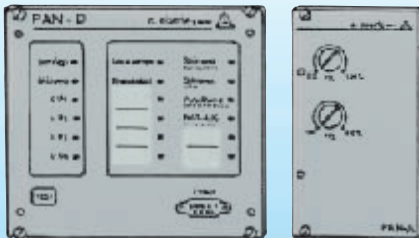

The safety of the voltage regulation is considerably increased by an additional surveillance of the net voltage with the monitoring unit. Malfunction of the voltage regulator which would lead to faulty switching operations can be eliminated by redundant voltage surveillance.
PAN - D is used for the surveillance of: net voltage (four limit values), regulator, tap-changer (lamp signal), phase sequence, free programmable binary

inputs and outputs and serial interface for bus connection.
 Power supply:
 AC: 85 V ... 264 V or
 DC: 18 V ... 72 V or 100 V ... 375 V
 plug-in group, width 28 TE (modules)
PAN - A is used for the surveillance of: net voltage (two limit values),
 Power supply from the measuring net (L1-L3)
 AC: 80 V ... 100 V ... 120 V
 plug-in unit, width 14 TE (modules)

Voltage regulator SR192-D

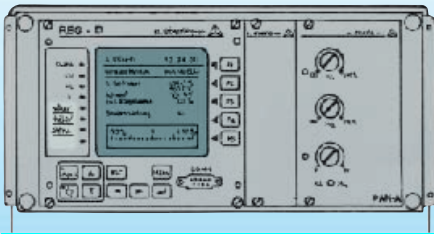

The voltage regulator system SR192-D can be used for standardized tasks. SR192-D fulfils the minimum requirements and consists of the components regulator REG - D and analogue monitoring unit PAN - A for two limit values of the net voltage.

Power supply:
 AC/DC: 20 V ... 60 V or 85 V ... 264 V
 DC: 18 V ... 72 V or 100 V ... 375 V
 The system is mounted into a plastic case, completely installed and wired.
 dimensions: 195 mm x 260 mm x 200 mm

Interface component REG - K REG - R



REG - K
 Interface component with four optocouplers for the binary regulator inputs BE1 ... BE4 and four relays for the binary outputs BA1 ... BA4 in order to increase the rated insulation voltage from 50 V to 250 V.
 Contact load:
 AC 250 V, 2 A, DC 220 V, 150 W
 Power supply: AC: 85 V ... 264 V or DC: 18 V ... 72 V or 100 V ... 375 V
 plug-in unit, width 7 TE (modules)





REG - R
 Interface component with four relays for the binary regulator outputs BA1 ... BA4 in order to increase the rated insulation voltage from 50 V to 250 V.
 Contact load:
 AC 250 V, 2 A, DC 220 V, 150 W
 Power supply:
 AC: 85 V ... 264 V or
 DC: 18 V ... 72 V or 100 V ... 375 V
 plug-in unit, width 7 TE (modules)

Interface component REG - S REG - F



Both interface components (diode matrix) are used for the conversion of up to 33 switching positions of the motor drive into the BCD-code.
 Admissible length between tap-changer and interface components: 100m
REG - S
 The BCD-signal is just edited once.
 Without power supply
 plug-in unit, width 7 TE

REG - F
 The BCD-signal is edited twice
 a) via diode matrix to the regulator
 b) potential free, via relay for the remote controlled engineering
 Power supply and control voltage for the motor drive switch:
 AC: 85 V ... 264 V or
 DC: 18 V ... 72 V or 100 V ... 375 V
 plug-in unit, width 8 TE

Type	Application / Description / Technical Data	
Interface component REG - M 	<p>An interface component for the autonomous change of the tap-changer control from manual to automatic operation.</p> <p>The tap position of the transformer can be changed by a button for tap position „higher“ and „lower“.</p>	<p>without power supply plug-in unit, width 14 TE</p>
Interface component ANA - D 	<p>An interface component used for the increase of the number of analogue inputs and outputs of the regulator REG - D.</p> <p>It disposes of eight free programmable analogue channels for the communication with the regulator REG - D via COM 3.</p> <p>Input: – 20 mA ... 0 ... + 20 mA or 10 V ... 0 ... + 10 V</p>	<p>Output: – 20 mA ... 0 ... + 20 mA or 10 V ... 0 ... + 10 V,</p> <p>Load: $I \leq 500 \Omega$ short-circuit-proof $U \geq 500 \Omega$ open-circuit protected</p> <p>Power supply: AC: 85 V ... 264 V or DC: 18 V ... 72 V or 100 V ... 375 V plug-in unit, width 8 TE</p>
Interface component BIN - D 	<p>An interface component to increase the number of binary inputs and outputs of the regulator REG - D.</p> <p>It has eight free programmable binary channels for the communication with the regulator REG - D via COM 3.</p>	<p>contact load: AC 250 V, 2 A, DC 220 V, 150 W</p> <p>Power supply: AC: 85 V ... 264 V or DC: 18 V ... 72 V or 100 V ... 375 V plug-in unit, width 8 TE.</p>
Interface component MMU - D 	<p>An interface component to extend the transducer functions of the regulator.</p> <p>The voltages and currents of a three phase system are recorded by three voltage transformers and by three current transformers and transmitted to the regulator REG - D via COM 3.</p> <p>Thus it is possible to measure all physically defined measured quantities in three-phase and four-phase systems under any load.</p>	<p>Power supply: AC: 85 V ... 264 V or DC: 18 V ... 72 V or 100 V ... 375 V plug-in unit, width 8 TE</p>
Accessories REG - ST / BO / PC 	<p>REG - ST E - LAN triple star distributor, with booster to link three regulators REG - D in end-end-operation. Admissible distance: 4 km at maximum. Additional two-wire connection for the linking of several star distributors. Admissible distance: 100 m at maximum</p> <p>REG - BO E - LAN booster bridges large distances between neighbouring regulators</p>	<p>REG - D in E - LAN; end-end-operation; Admissible distance: 4 km at maximum</p> <p>REG - PC E - LAN PC-adapter which connects the PC with the regulators REG - D which are linked to the bus.</p> <p>Power supply for REG - ST/BO/PC: AC: 85 V ... 264 V or DC: 18 V ... 72 V or 100 V ... 375 V wall-mount. case f. REG - ST/BO/PC: 106 mm x 150 mm x 123 mm</p>

Fax - Reply

a.eberle gmbh
Meß- und Regeltechnik
D-90441 Nürnberg

Fax no. + 49/911/66 66 64

Name

Company

Street

Town

Country

Phone no.

Fax no.

I/we wish to receive further information about your delivery program

- ground-fault tracing in inductively grounded medium voltage networks
- ground current relay
- three-phase calibrators
- components for the supervision of the net quality
- analogue function modules

I/we wish to receive information on your training courses/workshops

I/we wish to receive your customer information letters (technical reports)

I/we wish to arrange a personal demonstration/project meeting

I/we wish to receive more detailed information and/or an offer on:

Description	Type	Data sheet	Offer
Voltage Regulator	REG - D	<input type="checkbox"/>	<input type="checkbox"/>
Voltage Regulator	SR192 - D	<input type="checkbox"/>	<input type="checkbox"/>
Monitoring Unit	PAN - D	<input type="checkbox"/>	<input type="checkbox"/>
Monitoring Unit	PAN - A	<input type="checkbox"/>	<input type="checkbox"/>
Interface Components	ANA - D	<input type="checkbox"/>	<input type="checkbox"/>
	BIN - D	<input type="checkbox"/>	<input type="checkbox"/>
	MMU - D	<input type="checkbox"/>	<input type="checkbox"/>
	REG - K	<input type="checkbox"/>	<input type="checkbox"/>
	REG - R	<input type="checkbox"/>	<input type="checkbox"/>
	REG - S	<input type="checkbox"/>	<input type="checkbox"/>
	REG - F	<input type="checkbox"/>	<input type="checkbox"/>
	REG - M	<input type="checkbox"/>	<input type="checkbox"/>
Accessories			
E - LAN-star distributor	REG - ST	<input type="checkbox"/>	<input type="checkbox"/>
E - LAN-booster	REG - BO	<input type="checkbox"/>	<input type="checkbox"/>
E - LAN PC-adapter	REG - PC	<input type="checkbox"/>	<input type="checkbox"/>
triple E - LAN PC-adapter, without star distributor, with booster	REG - PC-3	<input type="checkbox"/>	<input type="checkbox"/>

www.a-eberle.de / www.regsys.de

a. eberle gmbh
 Aalener Straße 30/32
 D-90441 Nürnberg
 Phone no. +49/911/62 81 08 - 0
 Fax no. +49/911/66 66 64